



INSTALLATION AND OPERATING INSTRUCTIONS TOUCH CENTRE XL 4C WIRED

TOUCH CENTRE XL 4C WIRED



This manual is suitable for the following products::

- Touch Centre XL 4C Wired (01080212)

Documentnumber: 84500601 K1

Central control systems
for sun protection
systems, as well as for
skylights, lighting,
ventilation and heating

Read the manual before starting the installation.
Failure to follow the instructions may result in defects that are not
covered by the warranty. Errors and technical changes excepted.



Manual EN



Manual NL

CONTENT

■ Safety instructions	2	■ Description of symbols	63
■ Scope of delivery	3	■ Factory default settings	68
■ Technical data	4	■ Personal settings	71
■ Information for the installer	5	■ Troubleshooting	74
■ Installation assistant	24		
■ Information for the user	30		
■ Control unit warnings	61		

SAFETY INSTRUCTIONS

GENERAL SAFETY INFORMATION

These safety instructions are an integral part of the product and must be read and fully understood before installation, electrical connection, commissioning and operation.

- The Touch Centre XL 4C Wired is a central control unit for shading systems with up to four channels.
- The control unit is intended for operating shading systems such as awnings, venetian blinds or roller shutters in combination with suitable sensors and decentralised control units.
- Installation, electrical connection and commissioning may only be carried out by a qualified electrician.
- The device must be inspected for visible damage before installation. Damaged devices must not be put into operation.
- Any modification or alteration of the device is prohibited and will void all warranty and liability claims.
- The operator must ensure that these safety instructions are made available to all subsequent users.

SAFETY WARNINGS



ELECTRICAL HAZARDS

DANGER – Risk of fatal electric shock.

Disconnect the mains voltage completely before installation and before working on the device.



HAZARDS FROM MOVING SUN SHADING SYSTEMS | WARNING –

Risk of injury due to crushing, shear points or uncontrolled movements.



NOTE

The complete safety instructions can be found at: www.vestamatic.com/safety



SCAN ME

SUPPORT/CONTACT

Vestamatic International GmbH
Am Tannenbaum 2 | 41066 Mönchengladbach
E-Mail: info@vestamatic.com

SCOPE OF DELIVERY



Control unit comprising a display unit and a control unit



Wall-mounting plate for display box



Assembly instructions



Input stylus

ACCESSORIES



Luxsensor LS 30
(Art.No. 01161210)



WS XS
(Art.No. 01100310)



WS XS Alu
(Art.No. 01100410)



WS Classic M
(Art.No. 01100235)



RD +1°C
(Art.No. 010830)



RD +1°C V2.0
(Art.No. 010831)

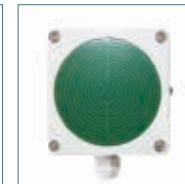

RD -20°C
(Art.No. 010825)



RD -20°C V2.0
(Art.No. 010826)



TS Pro XL
(Art.No. 01173010)



Thermostat TE Indoor
(Art.No. 01100271)



Thermostat TE Outdoor
(Art.No. 01100282)

TECHNICAL DATA

SHORT DESCRIPTION

- Color touch display with intuitively operable symbols
- 4-channel control system for individual control of all types of shading systems
- Simplified learning and parameterization through automatic sensor detection and help function
- Potential-free group outputs for controlling central control systems
- Connection options for: 2 × wind sensors, 8 × lux sensors, 1 × rain sensor, 2 × temperature sensors and radio timer on the control box
- Display box with integrated temperature sensor
- Individually programmable functions and sensors for wind, sun, rain and temperature per channel
- Connection options for external UP/DOWN buttons and maintenance switch
- Connection option for a potential-free contact of a fire alarm system
- Individually adjustable motor runtime / Tilting time
- Communication between control box and display box via 4-wire connection (4 × 0.8 mm²), RS485

PARAMETER	VALUE
Power supply	230VAC, 50 Hz
Impulse voltage withstand level	2,5 kV
Rated power	10 W
Max. output current	250VAC, 50 Hz, 4A, $\cos \varphi \geq 0,8$ ind.
Max. Gesamtschaltleistung	1380 W, 6A, 230VAC
Output max. load	3 – 180 seconds or continuous
Softwareclass	A
Cable cross-section	
Motor connection:	0,14 mm – 2,5mm ²
Sensors / push buttons:	0,14 mm – 1,5mm ²
Operating temperature	0 °C bis +40 °C
IP class	IP 20 (Control box), IP 20 (Displaybox)
Degree of pollution	2 (Control box), 2 (Displaybox)
Battery	CR 2032
Dimensions (L × B × H):	270 × 220 × 108 mm (Control box) 155 × 105 × 35 mm (Displaybox)
Color specification (standard versions)	Display box: black (similar to RAL 9005) Control box: light grey (similar to RAL 7035)
Conformity	

INFORMATION FOR THE INSTALLER

CONTROL BOX



NOTE

When connecting Skylights, the UP terminal corresponds to the movement command “close Skylight” and the DOWN terminal corresponds to “open Skylight”.



NOTE

- When connecting fan motors or heating/lighting systems, the UP terminal corresponds to the switching command “fan/heating/lighting ON”.
- The DOWN terminal corresponds to the OFF function for fan motors or heating/lighting systems.
- Observe the power consumption of the connected devices. The total power consumption must not exceed 1380 W. If the connected devices exceed 1380 W, the use of an isolating relay MC TR 1PF (0154720) per channel is required.

CONTROL BOX DIMENSIONS

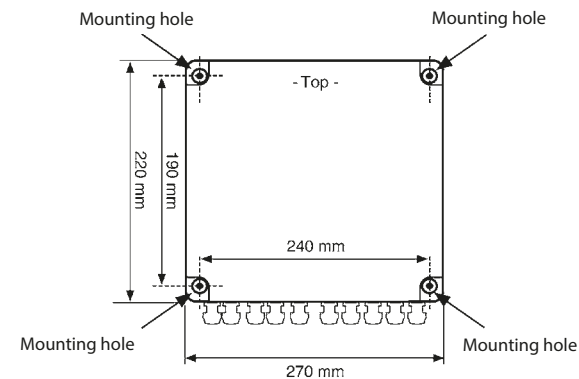

INSTRUCTIONS FOR ELECTRICIANS

- 1. Disconnect the mains supply voltage.
- 2. Loosen the screws of the housing cover, remove the control box cover and mount the housing using the outer mounting holes in the corners. Installation must be carried out so that the cable entries are located on the underside. The installation location of the control box must not be exposed to direct sunlight.
- 3. Route the connection cables through the cable entries on the underside into the housing and tighten the cable glands. Cables that are not required must be sealed. Maintain sufficient distance between mains and motor cables (230 V) and sensor/push-button cables (ELV); if necessary, bundle the cables with cable ties.
- 4. Connect the wiring according to the wiring diagram.
- 5. The output is potential-free (important for controlling central control systems).
- 6. If one or more motors (230 VAC, 50 Hz) are to be connected directly without isolating relays, a bridge must be installed between the Common terminal of the motor output and terminal L of the mains connection.
- 7. Refit the housing cover and tighten the housing cover screws.

INFORMATION FOR THE INSTALLER

CONTROL BOX WIRING DIAGRAM

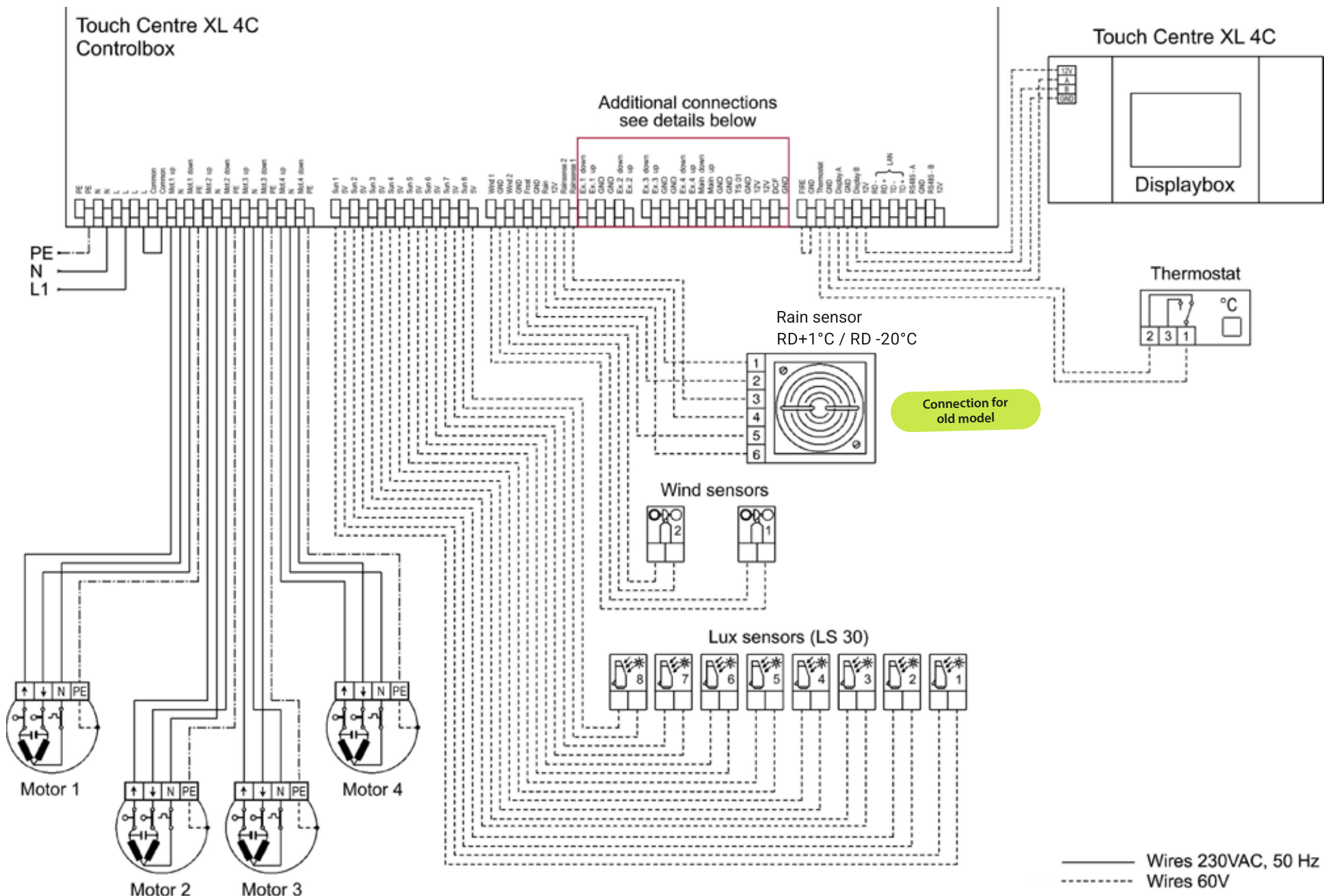

INFORMATION FOR THE INSTALLER

CONTROL BOX WIRING DIAGRAM

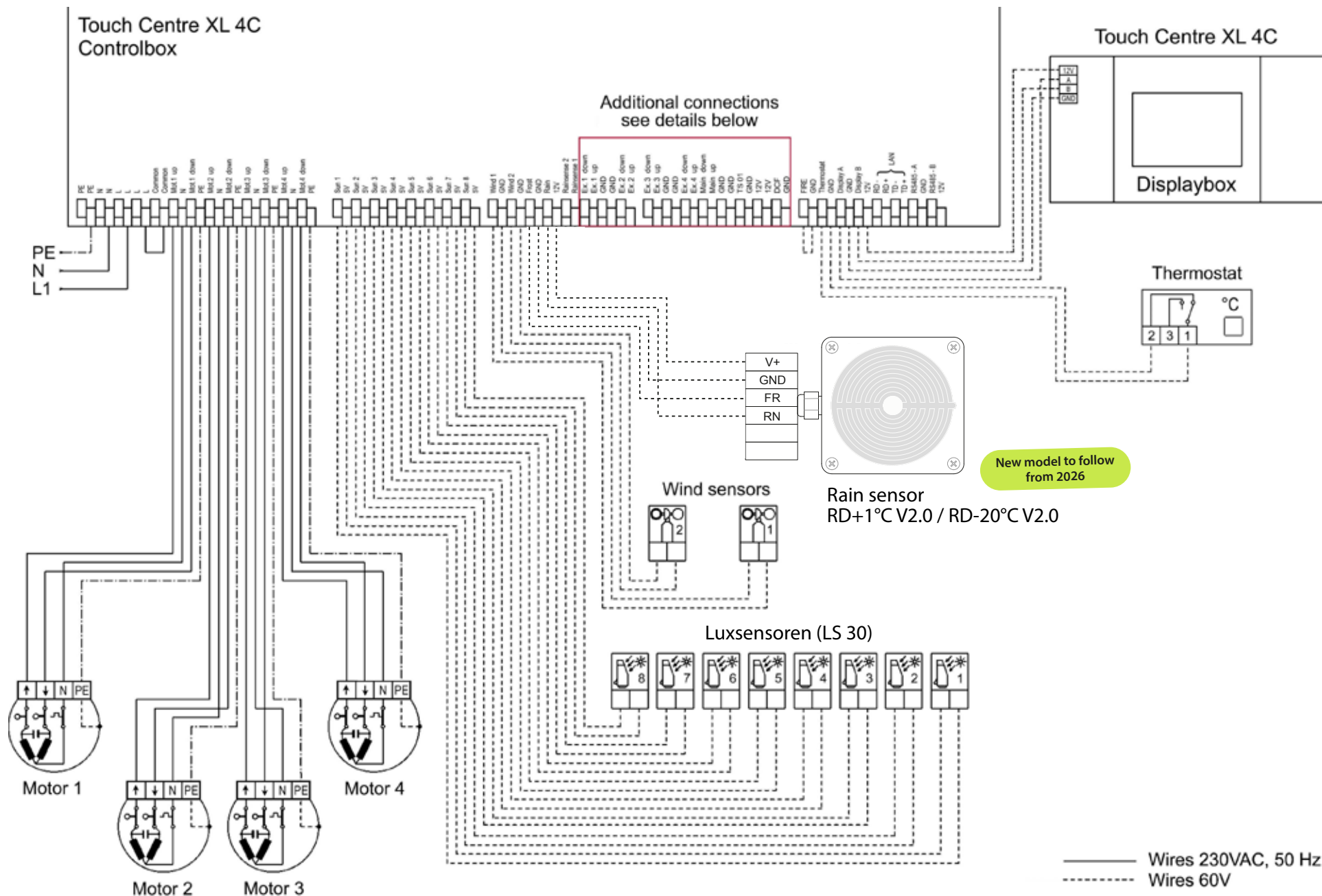

New model to follow from 2026

INFORMATION FOR THE INSTALLER

CONTROL BOX WIRING DIAGRAM

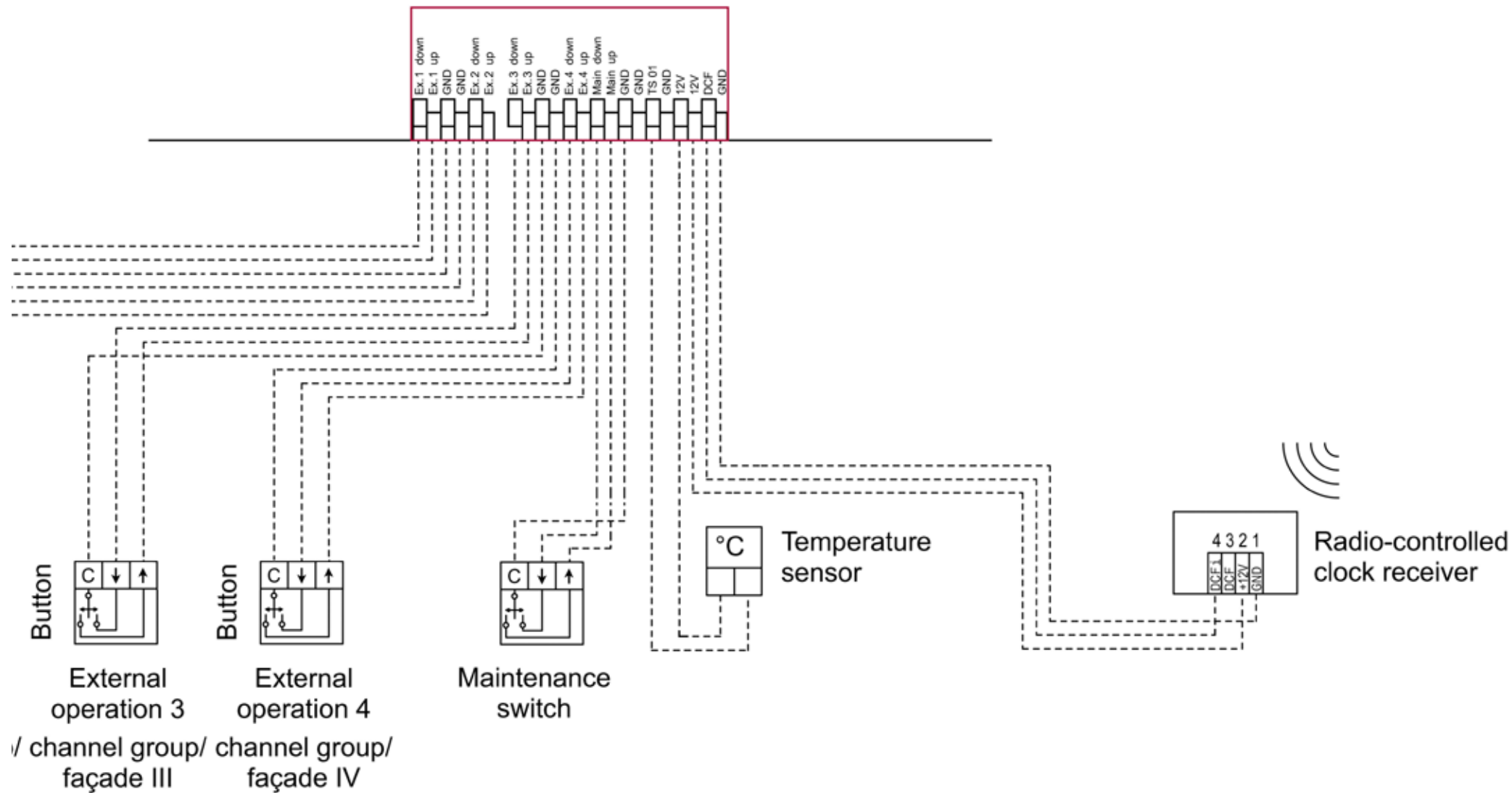

INFORMATION FOR THE INSTALLER

CONNECTION OF DECENTRALIZED CONTROL UNITS

The control unit is designed for connection to decentralized control systems. The switching current of the decentralized control units must not exceed 6 A.

Each output has its own connection terminal for UP and DOWN and is protected by a common fine fuse F2 (6.3 AT) in the control unit.

i NOTE

- When connecting decentralized control units, no jumper must be installed between terminals L and Common. A jumper installed here will destroy all connected decentralized control units.
- Simultaneous operation of potential-free control units and 230 VAC motors at the outputs of the control unit is not permitted.
- If both motors and decentralized control units need to be controlled, an output with a potential-free contact is required per channel group. In this case, an isolating relay MC TR 1 PF (0154720) must be used.

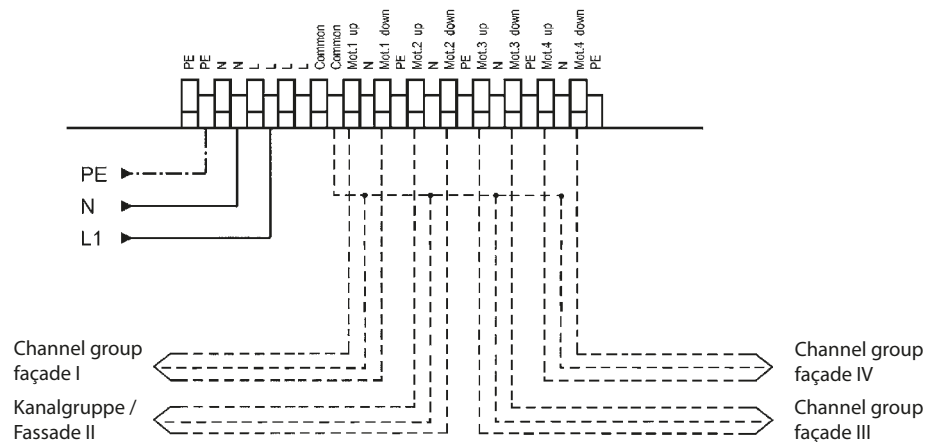
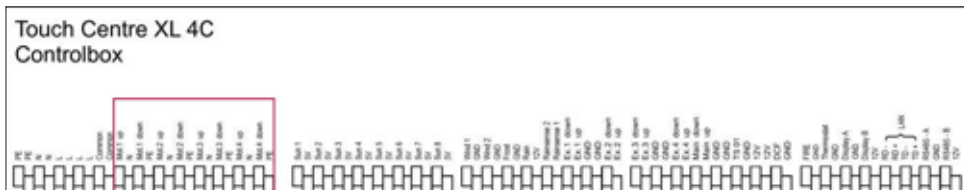

INFORMATION FOR THE INSTALLER

CONTROL BOX MOUNTING / CONNECTION OF WIND SENSORS

i NOTE

- The simultaneous connection of different wind sensor types or manufacturers is not permitted – risk of personal injury or property damage.
- If no wind sensor is connected to the respective input, a jumper must be installed.

OPERATING PRINCIPLE OF THE WIND SENSOR:

The wind sensor measures airflow independently of direction.

Wind speed is converted via a reed contact into electrical signals and transmitted to the control unit as a frequency. A cable break detection is also integrated.

MOUNTING OF THE WIND SENSOR:

For installation, we recommend the plastic mounting bracket, Art. No. 01272020, or the plastic mounting bracket for wind and sun sensors, Art. No. 01271020. Select the mounting height and position carefully to prevent damage caused by movement or high wind speeds.

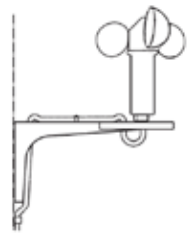

MOUNTING LOCATION:

- Choose a free, unobstructed position
- Ideally approx. 10 m above flat ground
- Maintain sufficient distance from obstacles (at least double the obstacle height)
- For roof installation: mount as close as possible to the roof ridge Transmit pulses as frequency to the control unit; cable break detection is integrated

MAINTENANCE / CLEANING:

- Install only in vertical position (protection against water ingress)
- Maintenance-free when installed correctly
- Clean with mild household cleaning agents if required

i NOTE

- Cable length: signal line can be extended from 5 m up to max. 100 m (with identical cross-section).

INFORMATION FOR THE INSTALLER

CONNECTION TERMINALS – WIND SENSORS

The two wind sensors are connected to the terminals Wind 1 and GND and Wind 2 and GND on the control box. Polarity of the wind sensors does not need to be observed.

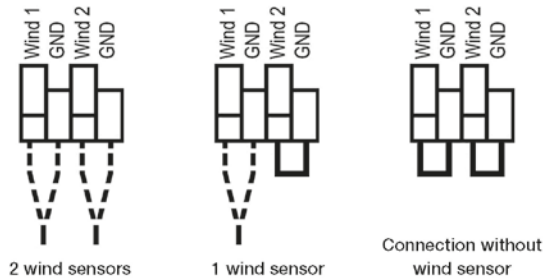
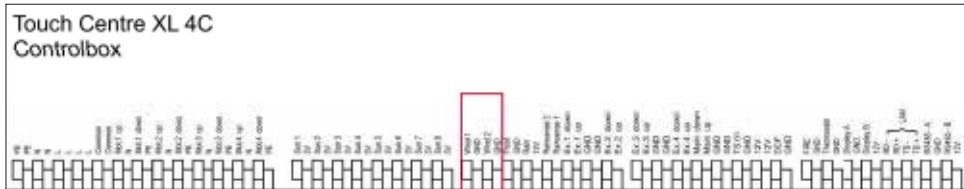

Fig.: Connection examples for wind sensors

CONTROL BOX MOUNTING / CONNECTION OF LIGHT (LUX) SENSORS

OPERATING PRINCIPLE OF THE LUX SENSOR:

The lux sensor measures daylight intensity and converts solar radiation into analog electrical signals that trigger control commands.

MOUNTING LUX SENSOR:

For installation, use the mounting bracket: Aluminium (Article No. 01100510) or plastic for wind and lux sensor (Article No. 01271020)
Route the cable downward and secure it properly to prevent damage caused by movement or wind.

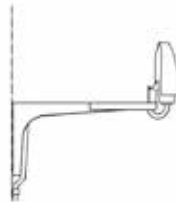

NOTE

Cable length: Signal cable from 5 m can be extended up to max. 100 m (with the same cross-section).

INFORMATION FOR THE INSTALLER

CONTROL BOX MOUNTING / CONNECTION OF LIGHT (LUX) SENSORS

INSTALLATION LOCATION:

- Detection angle approx. 120°
- No shading or obstacles in the measurement area
- For large façades: two sensors at a 45° angle for optimal detection

MAINTENANCE / CLEANING:

- Install vertically only (protection against water ingress)
- Maintenance-free with correct installation, Clean if necessary with mild household cleaning agents

CONNECTION TERMINALS – LUX SENSORS

The 8 possible lux sensors are connected to the terminals: Sun 1 and 5V, Sun 2 and 5V ... up to Sun 8 and 5V on the control box. Polarity of the lux sensors does not need to be observed.

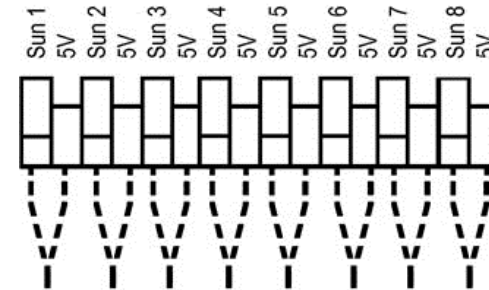
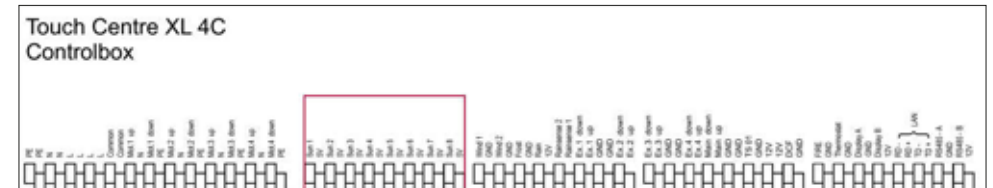

Fig.: Connection of lux sensors

CONTROL BOX INSTALLATION / CONNECTION OF RAIN SENSORS

OPERATING PRINCIPLE OF THE RAIN SENSOR:

The rain sensor detects humidity and temperature. Precipitation is converted into digital signals and triggers control commands. An integrated heater accelerates drying and shortens the feedback time for "Rain End".

INFORMATION FOR THE INSTALLER

CONTROL BOX INSTALLATION / CONNECTION OF RAIN SENSORS

FUNCTION DEPENDING ON TEMPERATURE:

- +1°C Variant: Heating active between approx. +1°C and +30°C; in case of frost, systems are closed and locked.
- -20°C Variant: Heating active down to -20°C; systems remain operational down to -20°C.

INSTALLATION OF RAIN SENSORS:

Installation with mounting bracket on holder possible. For installation, we recommend the mounting bracket made of aluminum, article no. 01100510. Secure the cable downward and fasten it properly to prevent damage caused by wind.

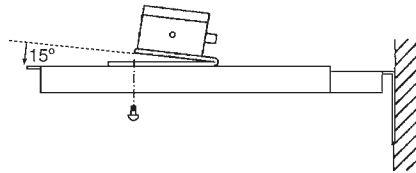

INSTALLATION LOCATION:

- Align sensor surface towards the weather side
- Tilt approx. 15° for better water drainage
- Ensure free positioning for reliable measurement

MAINTENANCE / CLEANING:

- Install with approx. 15° inclination (protection against water ingress)
- Maintenance-free if installed correctly
- Clean with mild household cleaning agents if required



NOTE

Cable length: Signal line can be extended up to max. 100 m (0.8 mm² cross-section).

TERMINAL CONNECTIONS – RAIN SENSORS

Rain Sensor Terminals	Signal RD+1°C and RD-20°C	Signal RD+1°C V2.0 and RD-20°C V2.0	Control Box Terminals	Personal notes
1	+12V	+12V	12V	
2	GND	GND	GND	
3	Sensitivity I		Rain sensor 1	
4	Sensitivity II		Rain sensor 2	
5	Frost signal	Frost signal	Frost	
6	Rain signal	Rain signal	Rain	

INFORMATION FOR THE INSTALLER

CONTROL BOX TERMINALS – RAIN SENSORS

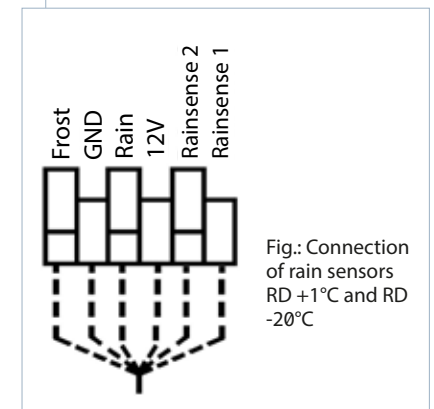
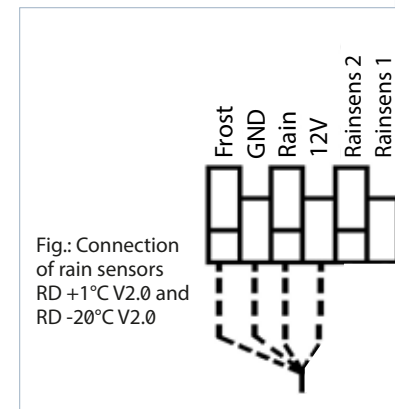
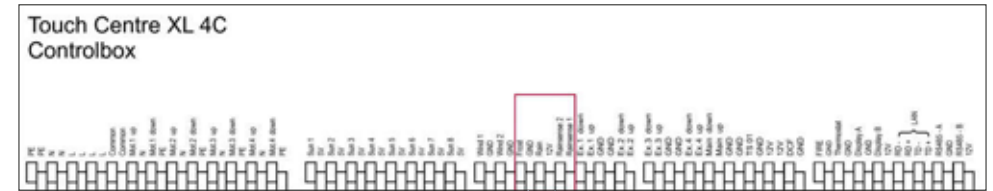

CONTROL BOX INSTALLATION / CONNECTION OF TEMPERATURE SENSORS TS PRO XL

OPERATING PRINCIPLE TS PRO XL:

Measures ambient temperature (-30°C to +55°C) and converts it into analog signals for control commands.

INSTALLATION TS PRO XL:

Installation with clip or holder possible. Secure cable properly to prevent damage caused by movement or wind.

TE INDOOR

OPERATING PRINCIPLE TE INDOOR:

The indoor temperature sensor TE Indoor is used to measure temperature indoors. The temperature range can be adjusted via the adjustment knob from +5°C to +30°C.

INSTALLATION TE INDOOR:

The outdoor temperature sensor is suitable for surface mounting or direct installation on a flush-mounted box with vertical mounting holes in indoor areas.

INFORMATION FOR THE INSTALLER

CONTROL BOX INSTALLATION / CONNECTION OF TEMPERATURE SENSORS TE OUTDOOR

OPERATING PRINCIPLE TE OUTDOOR:

The frost/temperature monitor TE Outdoor is used to measure temperature in outdoor areas. The temperature range can be adjusted via the setting knob from -20°C to +35°C.

INSTALLATION TE OUTDOOR:

The frost/temperature monitor is suitable for surface mounting outdoors with cable entry from below.

ALL TEMPERATURE SENSORS

INSTALLATION LOCATION:

- Avoid direct sunlight during installation of temperature sensors, otherwise the measured value will be incorrect.

MAINTENANCE / CLEANING:

- Maintenance-free if installed correctly
- Clean with mild household cleaning agents if required



NOTE

Cable length: Signal line can be extended from 5 m up to max. 100 m (with identical cross-section).

TERMINAL CONNECTIONS – TEMPERATURE SENSORS

- The temperature sensor TS Pro XL is connected to terminals TS 01 and +12V on the control box.
- The temperature sensor TE Indoor / TE Outdoor is connected with its internal terminals 1 and 2 to the terminals Thermostat and GND on the control box. The polarity of the temperature sensors does not need to be observed.

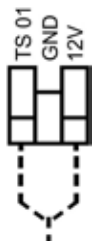
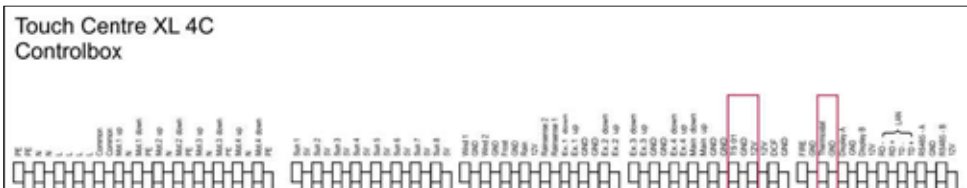

Fig.: Connection TS Pro XL



Fig.: Connection TE Indoor / TE Outdoor

INFORMATION FOR THE INSTALLER

CONTROL BOX CONNECTION OF PUSH BUTTONS FOR EXTERNAL OPERATION OF CHANNEL GROUPS

OPERATING PRINCIPLE PUSH BUTTONS:

Each channel group has its own UP/DOWN input on the control box.

A push button or switch can control one or multiple channel groups simultaneously.



NOTE

Max. 100 m when using cable JY ST(Y) 2 x 2 x 0.8.

TERMINAL CONNECTIONS – PUSH BUTTONS

Connect the push button for external operation to the required input and to one of the GND terminals.

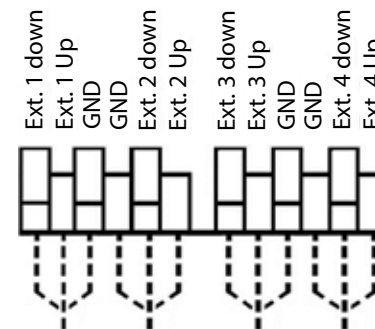
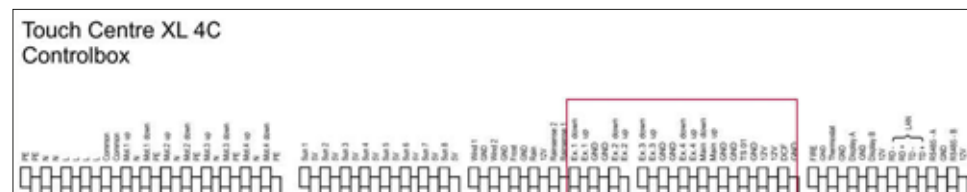

Fig.: Connection external push buttons

INFORMATION FOR THE INSTALLER

CONTROL BOX CONNECTION OF THE MAINTENANCE SWITCH FOR THE CHANNEL GROUPS

OPERATING PRINCIPLE MAINTENANCE SWITCH:

Via the maintenance input, all shading systems can be moved into a defined position (open or closed) and locked. This ensures safe execution of maintenance and cleaning work.



NOTE

Max. 100 m when using cable JY ST(Y) 2 x 2 x 0.8.

TERMINAL CONNECTIONS – MAINTENANCE SWITCH

Connect the maintenance switch to the terminals Main down, Main up and GND.

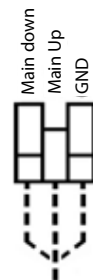
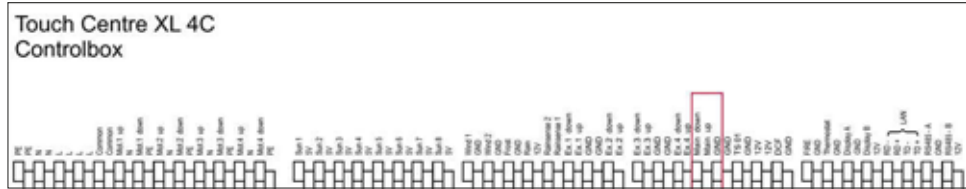

Fig.: Maintenance connection



NOTE

In case of fire and/or wind alarm, all shading systems are always retracted immediately. Therefore, if maintenance work is carried out in the extended position on connected systems, the power supply of the respective system or the control box must be switched off beforehand.

INFORMATION FOR THE INSTALLER

CONTROL BOX CONNECTION TO A SMOKE / FIRE ALARM SYSTEM

OPERATING PRINCIPLE FIRE ALARM SYSTEM:

The fire alarm system connects the control unit to a smoke/fire alarm system. In the event of an alarm, all shading systems are immediately retracted, Skylights are closed, and the system is locked. Local operation is then no longer possible.

CONNECTION FIRE ALARM SYSTEM:

Connection via a potential-free (dry contact) contact of the fire alarm system. If no connection is made, a wire bridge between "Fire" and "GND" must be installed.



NOTE

Max. 100 m when using cable JY ST(Y) 2 x 2 x 0.8.

TERMINAL CONNECTIONS – SMOKE / FIRE ALARM SYSTEM



If not connected to the BMS!



NOTE

The wire bridge is only required if the control unit is not connected to a smoke/fire alarm control panel.

Fig.: Connection smoke/fire alarm system

INFORMATION FOR THE INSTALLER

DISPLAYBOX CONNECTION TO THE CONTROL BOX VIA 4-WIRE INTERFACE

OPERATING PRINCIPLE DISPLAYBOX:

The power supply of the display box and the data exchange are carried out via the 4-wire interface. For this purpose, the display box must be connected to the control box.



NOTE

Max. 100 m when using cable JY ST(Y) 2 x 2 x 0.8.

TERMINAL CONNECTIONS – DISPLAYBOX

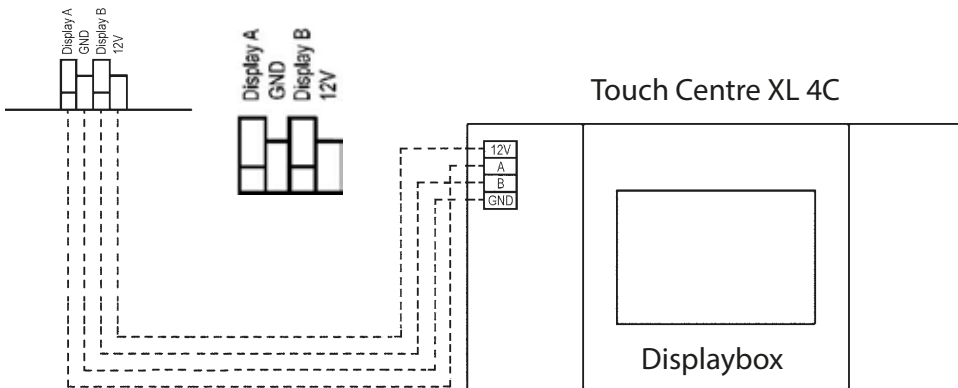
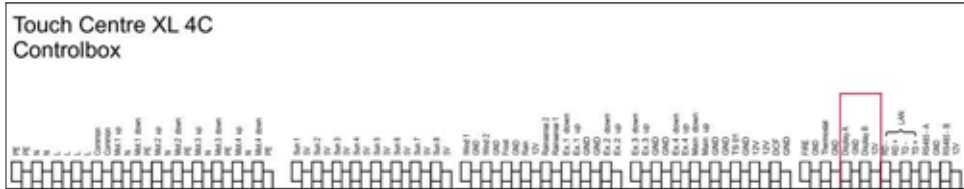

NOTE

Check the connection before commissioning. Incorrect connection may lead to damage to

INFORMATION FOR THE INSTALLER

MOUNTING THE DISPLAY BOX

PREPARING THE MOUNTING PLATE FOR INSTALLING THE DISPLAY BOX

Remove the pre-punched cable entry in the mounting plate (see Fig. 1, red marked area) using a screwdriver, etc. Then route the connection wires of the 4-wire interface through the cable entry (see Fig. 2) of the mounting plate and mount the mounting plate accordingly.

STEP 1

Remove the pre-punched cable entry in the mounting plate (red marked area) using a screwdriver, etc.

STEP 2

Route the connection wires of the 4-wire interface through the cable entry of the mounting plate and mount the mounting plate accordingly.



CONNECTION OF THE DISPLAY BOX

- Remove the 6 screws on the rear side of the display box housing.
- Remove the housing cover.
- Use a screwdriver to break out the pre-punched cable entry (see red marked area).
- Route the cable of the 4-wire interface and connect it according to the wiring diagram (see next page).
- Refit the housing cover and fasten it again with the 6 screws.
- The display box can then be hooked into the mounting plate.



INSTALLATION ASSISTANT (WIZARD)

OVERVIEW

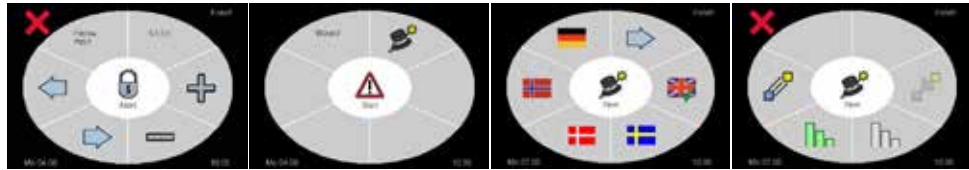

1. Password query 2. Wizard start 3. Language selection for user interface 4. Detection of communication setup

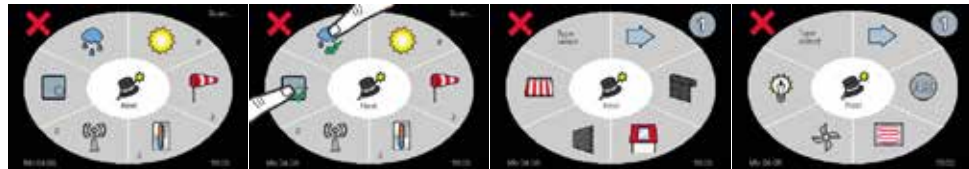

5. Scan of connected sensors 6. Manual activation of rain sensor and/or temperature sensor 7. Type selection of the respective channel group 8. Type selection of the respective channel group

Selection of connected Lux sensors



9. Selection of Lux sensor 10. Assignment of lux sensors (sun), sensors 1 to 4 11. Assignment of lux sensors (sun), sensors 5 to 8

Selection of connected wind sensors



12. Selection of wind sensors 13. Assignment of wind sensors, setting wind limit and wind sensor 14. Setting wind sensor type: WM1 or WM2

Selection of connected temperature sensors



15. Selection of temperature sensors 16. Assignment of temperature sensors: internal temperature sensor display box, TE Indoor, TE Outdoor or TS Pro XL

INSTALLATION ASSISTANT (WIZARD)

OVERVIEW

Selection of connected rain sensors

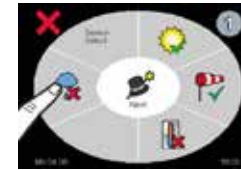

17. Activation of rain sensor

Repeat the settings for channel groups 2–4, following steps 9 to 18 depending on the connection.

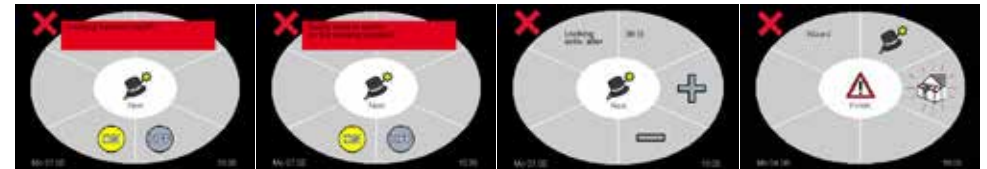

18. Activation of device locking function 19. Security query for activating the device locking function 20. Setting the number of days the device is locked 21. Setting option for safety position – wizard end

GENERAL NOTES

The installation assistant, also called wizard, is designed to help you with commissioning the control unit. Step by step, you are guided through the installation program and configure the channel groups/facade outputs as well as the connected sensors.

BASIC BUTTONS AND THEIR FUNCTION

- To the next menu
- To the previous menu
- To the next page of the menu

SETTINGS



PASSWORD QUERY

Enter the 4-digit security code to access the installation program. Use the + and – buttons to adjust the numbers and the arrow buttons to move to the next position.

After entering the security code, press the confirm button to proceed to the next menu. The “Wizard Start” menu will appear.

NOTE

The 4-digit security code can be found on the invoice.

It is intended exclusively for qualified personnel and must not be passed on to end users.

Sharing the code may disable safety-relevant settings and lead to personal injury or property damage.

INSTALLATION ASSISTANT (WIZARD)

SETTINGS



WIZARD START

To start the wizard (installation assistant), press the Start button. The menu "User interface language settings" (Install) will appear.



SETTING THE USER INTERFACE LANGUAGE (INSTALL)

In this menu, you define the language in which the user interface will be displayed. Confirm the language selection with a checkmark.

To select additional languages: Press the **arrow button** to go to the next page (2 + 3) of this menu.

DETECTION OF COMMUNICATION SETUP



DETECTION OF COMMUNICATION SETUP (INSTALL)

In this menu, the connection between the control box and the display box is displayed.

- Connection via 4-wire interface
- Connection via radio (no function)
- No connection quality
- Low connection quality
- Sufficient connection quality
- Good connection quality



SCAN OF CONNECTED SENSORS

In this menu, all connected and functional sensors are checked and displayed:

- Light sensor LS 30
- Wind sensor WM1 or WM2
- Temperature sensor internal or TS Pro XL
- Radio clock receiver
- Thermostat TE Indoor or TE Outdoor
- Rain sensor RD +1°C or RD -20°C

INSTALLATION ASSISTANT (WIZARD)

i NOTE

The rain sensor and the thermostat are not detected automatically. If these sensors are installed, they must be activated manually.

To do this, tap the corresponding symbol so that a checkmark appears behind the respective sensor.



TYPE SELECTION OF THE CONNECTED CHANNEL GROUP PAGE 1

In this menu, you can assign each individual channel group to a specific control type as well as the sensors and settings. The following control types are available:

- Awning
- Venetian blind
- Skylight
- Roller shutter



TYPE SELECTION OF THE CONNECTED CHANNEL GROUP PAGE 2

In this menu, you can assign each individual channel group to a specific control type as well as the sensors and settings. The following control types are available:

- Lighting
- Ventilation
- Heating
- Not connected (no function, no connection)

i NOTE

The currently edited channel group is displayed at the top right of the display (1).

After completing the function selection, the automatic sensor assignment for this channel group follows. Afterwards, the system switches to the next channel group (2).



Beispiel

SENSOR SELECTION OF THE CONNECTED SENSORS

Possible sensor assignment depending on the type selection:

Control type	possible sensor assignment
Awning	Sun, Wind, Temperature, Rain
Venetian blind	Sun, Wind, Temperature, Rain
Skylight	Wind, Temperature, Rain
Roller shutter	Sun, Temperature
Lighting	No sensor assignment possible
Ventilation	Temperature
Heating	Temperature
Not connected	No sensor assignment possible

i NOTE

The **X** is displayed as long as no corresponding sensor is assigned.

As soon as the corresponding sensor is activated, a **✓** appears next to the respective sensor.

INSTALLATION ASSISTANT (WIZARD)

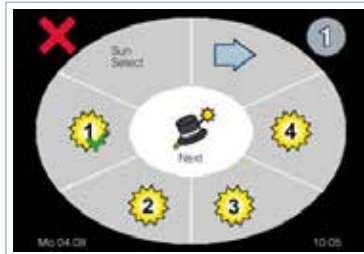

SENSOR ASSIGNMENT – SUN

In this menu, one or more light sensors can be assigned to the respective channel group. To do this, the corresponding light sensor must be activated by clicking on it. After confirmation and activation, a ✓ appears next to the respective sensor.

Page 1 = Light sensor selection 1 to 4 (shown in illustration)
Page 2 = Light sensor selection 5 to 8 (not shown here)

SENSOR ASSIGNMENT – WIND

i NOTE

The wind sensor can only be activated/deactivated and selected in this menu. Wind sensors are deactivated by default and must be activated manually. Simultaneous connection of different wind sensor types or manufacturers is not permitted and may lead to personal injury or property damage.



SENSOR ASSIGNMENT – WIND

In this menu, one or two wind sensors can be assigned to the respective channel group. To do this, the corresponding wind sensor must be activated/deactivated by clicking on it. After confirmation and activation, a ✓ appears next to the respective sensor.

Use the + and – buttons to set the wind threshold in km/h or m/s.

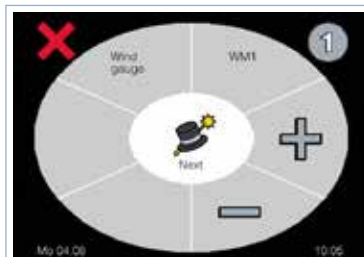

SETTING WIND SENSOR TYPE

In this menu, the wind sensor type used is defined. The following sensor types can be selected:

Type WM1 = WS XS, WS XS Alu
Type WM2 = WS Classic M

SENSOR ASSIGNMENT – TEMPERATURE OR RAIN

i NOTE

A connected temperature or rain sensor must be activated manually beforehand (see also “Scan of connected sensors”).

INSTALLATION ASSISTANT (WIZARD)



SENSOR ASSIGNMENT – TEMPERATURE

In this menu, the internal temperature sensor in the display box, a thermostat connected to the control box, or the temperature sensor TS Pro XL can be assigned to the respective channel group. To do this, the corresponding sensor must be activated by clicking on it. Only one of the three sensors can be assigned per channel group:

- Internal temperature sensor in the display box
- Thermostat connected to the control box (TE Indoor / TE Outdoor)
- Temperature sensor TS Pro XL connected to the control box

Example



SENSOR ASSIGNMENT – RAIN

In this menu, the rain sensor can be assigned to the respective channel group. To do this, the rain sensor must be activated by clicking on it. After confirmation and activation, a ✓ appears next to the rain sensor.

DEVICE LOCK FUNCTION



DEVICE LOCK FUNCTION

After activation, the device is locked once the set number of days has elapsed. Unlocking is performed via a 4-digit code.

ON: Activation with security prompt
OFF: Deactivation, jump to menu “Wizard End”



With **ON** and **Next**, the device lock function is activated. Then the number of lock days is set.

The lock duration is defined using the + and – buttons.

INSTALLATION ASSISTANT (WIZARD)

DEVICE LOCK FUNCTION

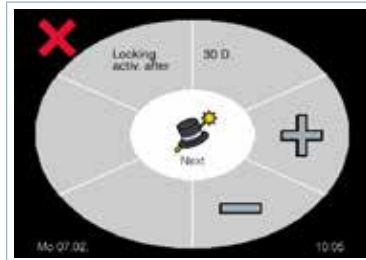

The days of the lock duration are set using the + and – buttons.

You will find the 4-digit unlock code on the invoice for the control unit. The unlock code is intended only for qualified personnel and must not be disclosed to end users.



WIZARD END

If the configuration for all channel groups has been completed, the system checks all functions of the installation. During this process, all shading systems move to the upper end position or Skylights are closed. This extend/retract command is displayed during the wizard by a flashing symbol.

Press End to finish the configuration of the control unit.

WARNING

Before moving to the safety position, ensure that no installation, maintenance or repair work is being carried out on the system. There is a risk of personal injury or property damage due to sudden movement of the systems. Exit the wizard using the End button.

INFORMATION FOR THE USER

GENERAL NOTES

The Touch Centre control unit is a central, microprocessor-controlled unit for controlling shading systems, lighting, ventilation and heating. Control is carried out automatically based on sensor values such as solar radiation, wind, rain, temperature and time of day. All settings, safety-relevant changes, as well as fault and alarm messages are stored in the system.

TOUCHSCREEN NOTES

The touchscreen is a sensitive component:

- Do not use sharp or pointed objects
- Do not press hard or scratch
- Clean only with a soft, suitable cloth (e.g. glasses cleaning cloth)
- The display can be locked during cleaning

INFORMATION FOR THE USER

OPERATING MODES AND CONTROL

AUTOMATIC MODE:

Fully automatic control of all connected systems considering all sensors and safety functions.

MANUAL MODE:

Direct control of individual channel groups.

Safety functions are only partially active here (depending on sun, temperature and time).

THE DISPLAY SHOWS:

- Active channel group
- Operating mode
- Date and time
- Sensor values and status messages

SWITCHING FROM AUTOMATIC TO MANUAL CONTROL



- ✓ Channel group must be active
 - ☺ Display shows operating mode
 - ☺ Clicking the symbol switches the selected channel group
- Example shown: Auto mode



Automatic control



Manual control

MANUAL CONTROL OF SHADING / SKYLIGHTS

- ↑ Retract shading / open Skylight
- ↓ Extend shading / close Skylight
- ↑↓ Stop movement by pressing the opposite button

MANUAL CONTROL OF LIGHTING / HEATING / VENTILATION

- ☺ Switch ON, ☺ = symbol indicates that it is switched on
- ☹ Switch OFF, ☹ = symbol indicates that it is switched off

NOTE

Even in automatic mode, manual control of the channel group via the UP/DOWN buttons is possible. If manual intervention occurs during automatic mode, the system will return to automatic operation in the next control cycle.

INFORMATION FOR THE USER

WEATHER INFO

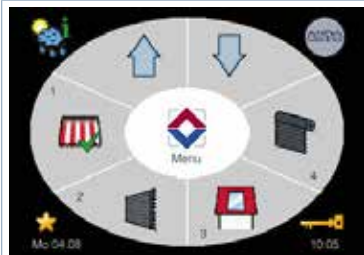

Example

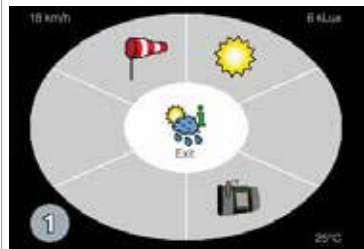

WEATHER INFO / STATUS DISPLAY 🌤️

Using the Weather button 🌤️ the weather data of the assigned sensors can be accessed. The highest value of a sensor group is displayed. If multiple lux sensors are assigned, the value with the highest intensity is shown.

Additionally, the currently executed command of the selected channel group is displayed.

🏠 = Return to main screen

Example sensor values for channel group 1:

Wind speed: 18 km/h
Solar intensity: 6 klux
Temperature: 25 °C

DISPLAY LOCK



LOCK / UNLOCK DISPLAY 🔑

The display can be locked for cleaning purposes or to prevent unauthorized access. Press the button 🔑 for 3 seconds to lock the display.

A symbol appears on the display indicating that it is locked: ❌

Unlock: press for 🔑 3 Sec.

COMFORT PROGRAM



COMFORT PROGRAM FOR SETTING SCENARIOS ⭐

The comfort program allows the creation of up to 4 individual scenarios. These can be activated manually via the corresponding scenario button. Each scenario can control the channels differently.

(see next page)

INFORMATION FOR THE USER

COMFORT PROGRAM



COMFORT PROGRAM FOR CONFIGURING SCENARIOS

Open menu: Press and hold the Menu symbol ⭐ for approx. 3 seconds. Then select the desired scenario (1–4). The active scenario is indicated by a flashing symbol: ⭐



Setting a scenario

For the desired scenario, press the corresponding button ⭐ for 3 seconds.

The following settings are possible:

- Runtime (e.g. travel time of shading systems)
- Tilting time (e.g. slat adjustment)

Adjust values using the + / - buttons



Feedback







































A programmed scenario is indicated by a green check mark: ✅

i NOTE

When a comfort program is executed, an initial movement command is always performed first (extend shading / close Skylights). After completion of this command, the systems move into the programmed position of the selected comfort program.

INFORMATION FOR THE USER

GRUNDEINSTELLUNGEN KURZÜBERSICHT

<p>User menu</p>  <p>Press button  to access the basic settings – details 1/3 to 3/3</p>	<p>Basic settings Detail 1/3</p> 	Setting the time / date 	Time 	Year 	Month 	Day 	Summer/winter time adjustment 	
		Setting the display colour selection 	Colour selection 					
		Setting the display standby time 	Standby time 					
		Release following fire alarm 	Password input 	Fire 				
	<p>Basic settings Detail 2/3</p> 	Network settings 	IP Block 1 	IP Block 2 	IP Block 3 	IP Block 4 	<i>without Function</i>	
		Display logbook 	Logbook 					
		Display contact details 	Contact 					
		Display software version 	Software version 					
		<p>Basic settings Detail 3/3</p> 	Move to safety position 	Safety position 				
	Touchscreen calibration 		Left top 	Right bottom 	Successful 			
	Display/Start wizard 		Password input 					
	Start Reset – Factory settings 		Password input 					

INFORMATION FOR THE USER

BASIC SETTINGS DETAIL 1/3 | ENTERING THE MENU



SWITCH TO OPERATING MENU / BASIC SETTINGS MENU

Use the **Menu button** to access the operating menu or the basic settings. The basic settings are divided into 5 pages (Detail 1/3, Detail 2/3 and Detail 3/3).

i NOTE

If no further input is made in the basic settings menu, the system automatically returns to the operating menu after 2 minutes. All changes made are saved automatically.

BASIC SETTINGS DETAIL 1/3



BASIC SETTINGS DETAIL 1/3

Available settings:

- Setting date, time, year, month, day, summer/winter time
- Setting display color
- Setting display standby time
- Release after fire alarm
- Go to page 2 of the basic settings or back to page 1

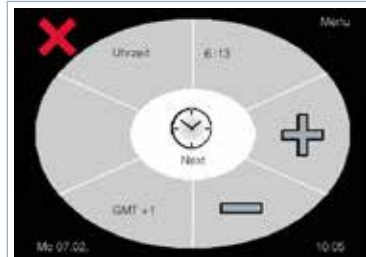

SETTING DATE / TIME

Set your time zone (GMT – Greenwich Mean Time) using the **button**, and adjust the current time using the **+ / -** buttons.

- Setting year
- Setting month
- Setting day
- Setting summer / winter time
- indicates the active function

i NOTE

Since the clock is buffered by a battery, date and time are retained even in case of power failure. If a radio time receiver is connected and a sufficient signal is available, the time and date are set automatically.

INFORMATION FOR THE USER

BASIC SETTINGS DETAIL 1/3

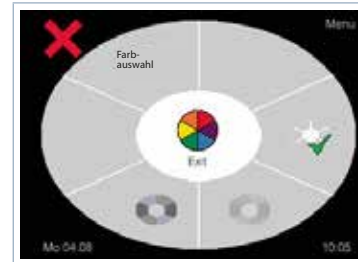

SETTING DISPLAY COLOR

Use the selection to choose between two different display background colors.

indicates the active function.

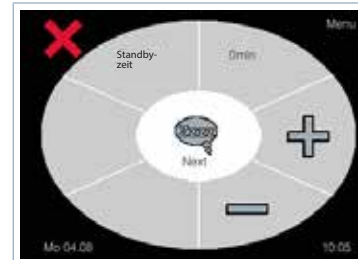

SETTING DISPLAY STANDBY TIME

Set the standby time between 1 and 15 minutes using the **+ / -** buttons.

After the selected time has elapsed, the display switches off. Touching any point on the touchscreen turns the display back on.

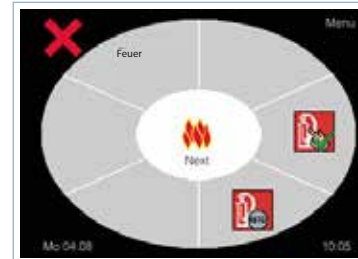

RELEASE AFTER FIRE ALARM

This menu is password-protected (password is on the invoice) and is only accessible to the installer. Here you define how the control system behaves after a fire alarm has been reset:

- Automatic release of the control system after fire alarm
- Release only after user confirmation

i NOTE

A fire alarm causes: Immediate retraction of shading systems. Closing of Skylights
Connected ventilation systems and heaters are switched off immediately

BASIC SETTINGS DETAIL 2/3



BASIC SETTINGS DETAIL 2/3

On this page, you can configure the LAN connection, view the log, view contact details, or check the software version of the display and the control box.

- Configure the LAN connection (without funktion)
- Display the logbook
- View contact information
- Retrieve software versions of the display and control box

INFORMATION FOR THE USER

BASIC SETTINGS DETAIL 2/3



NETWORK SETTINGS (NO FUNCTION)

In this menu, the IP address for network connection is configured. The 4 blocks are entered sequentially as three-digit values. Use the + / - buttons to adjust the values.

After changing the network settings, a reset of the control box is performed. This triggers a closing command for the connected systems.

i NOTE

After changing the network settings, the control box is reset. This results in a closing command for the connected systems.

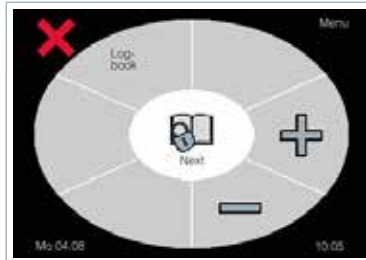

LOGBOOK DISPLAY

All sensor faults and alarm messages are stored in the control system logbook. Safety-relevant changes are also recorded. You can view the different logbook entries here. The logbook can only be deleted by the manufacturer. All entries are stored electronically and are not lost.



DISPLAY CONTACT DATA

This page provides information for contacting the manufacturer.

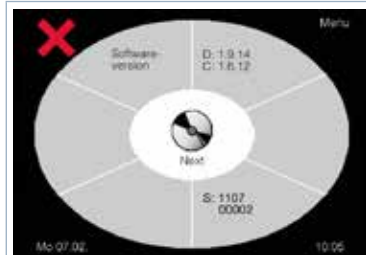

DISPLAY SOFTWARE VERSION AND SERIAL NUMBER

This page shows information about the software version and serial number of the control system.

INFORMATION FOR THE USER

BASIC SETTINGS DETAIL 3/3



BASIC SETTINGS DETAIL 3/3

Available settings:

- Move to safety position
- Calibrate touchscreen
- Start wizard
- Reset control system to factory settings
- Return to page 1 of the basic settings

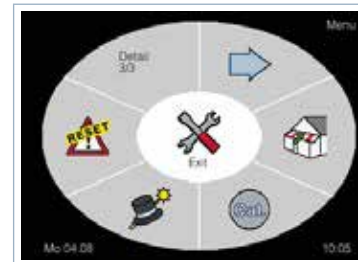

MOVE TO SAFETY POSITION

Press the button to move all shading systems to the upper end position, or to close Skylights.

Before activating the safety position, ensure that no installation, maintenance, or repair work is being carried out on the systems.

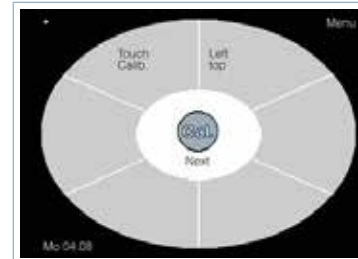

CALIBRATION TOUCHSCREEN

After extended use, the accuracy of the touchscreen may decrease. In this case, recalibration is required. Procedure:

- Start calibration via the corresponding button
- Tap the flashing point at the top left
- Then tap the flashing point at the bottom right

If calibration is successful, exit via "Next". If an error occurs, repeat the process.



DISPLAY / START WIZARD

Use this button Use this button to make changes to the installation settings, e.g.: Adding a motor type to a free channel group Expanding a channel group with additional sensors

After pressing the button, you will be prompted to enter a security code. Without the security code, no changes can be made.

i NOTE

The menus WIZARD and FACTORY SETTINGS (see next page) are password-protected for security reasons. The 4-digit security code can be found on the invoice. This code is intended exclusively for qualified professionals.

INFORMATION FOR THE USER

BASIC SETTINGS DETAIL 3/3



MOVE TO SAFETY POSITION

Using the "Factory settings" button, , the control system can be reset depending on the selected security code:

Security code 4668:

Deletes only personal settings such as threshold values or delay times and restores factory settings.

Security code XXXX:

Please refer to the security code on the invoice. With this code, all settings and assignments are deleted. The system is reset to factory condition and must be fully reconfigured.

After pressing the button , you will be prompted to enter the security code. Without the security code, no changes can be made (see password menu).

ADVANCED SETTINGS DETAIL 1/5

Advanced settings allow individual adjustments per channel group.

You can configure: Threshold values, Delay times, Tilting times, Fixed travel times. The menu consists of 5 pages with different configuration options.

Functions marked with  cannot be activated or adjusted.

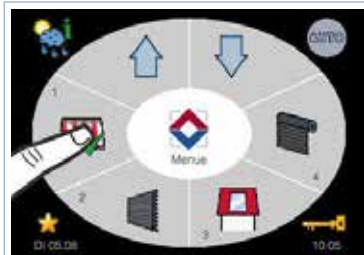

SWITCH TO OPERATING MENU / ADVANCED SETTINGS MENU

Press and hold the desired channel group button (e.g. awning) for 3 seconds to access the advanced settings for that channel.



NOTE

If no further input is made in the advanced settings menu, the system automatically returns to the operating menu after 2 minutes. All changes are saved automatically.

Overview of the fine-tuning options, see the next page.



















INFORMATION FOR THE USER

Quick reference guide



User menu

Press and hold the button for the desired channel group for 3 sec. in order to make fine adjustments to that function.

Detail 1/5	Detail 2/5	Detail 3/5	Detail 4/5	Detail 5/5
 Sun function <ul style="list-style-type: none"> Extension sun threshold Extension response time Retract time delay Retract sun threshold Sun motor runtime Number of sun-dependent extension commands per day 	 Motor run time <ul style="list-style-type: none"> Motor run time  Tilting function <ol style="list-style-type: none"> <u>Tilting time „Season“</u> <ul style="list-style-type: none"> Tilting time spring ... Tilting time winter Tilting assignment <u>Tilting time „Table“</u> <ul style="list-style-type: none"> Tilting time January (Time 1 bis 4) ... Tilting time December (Time 1 bis 4) Tilting assignment 	 MC DZ M/J function  Inching mode function	 UP time function <ul style="list-style-type: none"> Monday UP Monday duration ... Sunday UP Sunday duration 	 Heating function <ul style="list-style-type: none"> Temperature threshold Anti-freeze Reset delay Temperature unit
 Rain function <ul style="list-style-type: none"> Password input Reset delay Sensitivity setting Manual extension when rain/frost 	 Continuous up command  Continuous down command	 Holiday function  Astro function <ul style="list-style-type: none"> Astro setting Longitude LON Latitude LAT Up time correction Down time correction 	 DOWN time function <ul style="list-style-type: none"> Monday DOWN Monday duration ... Sunday DOWN Sunday duration 	 Ventilation function <ul style="list-style-type: none"> Temperature threshold Reset delay Temperature unit
 Wind function <ul style="list-style-type: none"> Password input Wind threshold 1 Wind threshold 2 Response delay Reset delay Wind unit 			 Automatic mode lock <ul style="list-style-type: none"> Monday OFF Monday duration ... Sunday OFF Sunday duration 	
 Temperature function <ul style="list-style-type: none"> Temperature threshold 1 Temperature threshold 2 Runtime for temperature threshold 2 Reset delay Temperature unit 			 Handheld transmitter <ul style="list-style-type: none"> Programming / Deleting <p><i>(without function)</i></p>	



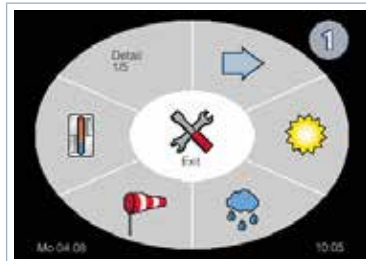

INFORMATION FOR THE USER

ADVANCED SETTINGS DETAIL 1/5



ADVANCED SETTINGS DETAIL 1/5

The following settings are available:

-  Sun function
-  Rain function
-  Wind function
-  Temperature function

 Go to page 2 of the advanced settings or return to page 1

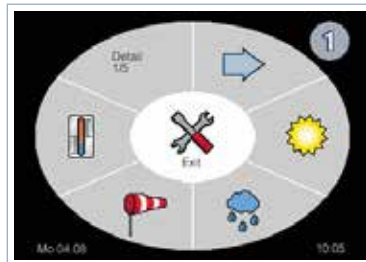

SUN FUNCTION

The sun function controls the connected shading system automatically depending on the intensity of solar radiation. Function can be activated for the following control types:

- Awnings
- Roller shutters
- Venetian blinds

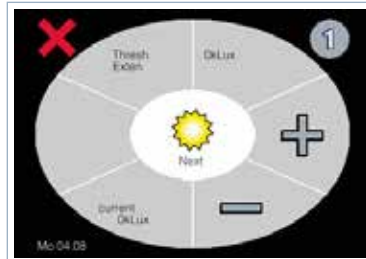

SETTING SUN THRESHOLD VALUE (EXTEND)

In this menu, a threshold value in klux is defined at which the shading system extends. Additionally, the currently measured solar intensity is displayed in the lower left of the display.

The threshold value can be adjusted individually using the + / - buttons.

Setting range: OFF, 11 – 100 klux

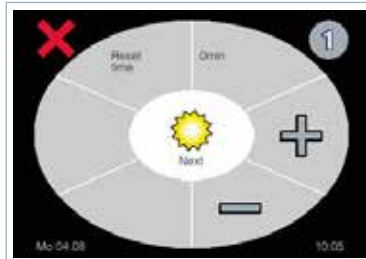

SETTING RETURN DELAY (RETRACT)

The return delay delays the retraction of the shading system after the threshold value for retraction has been reached. The delay can be set in minutes using the + / - buttons.

Setting range: 1 – 60 minutes

INFORMATION FOR THE USER

ADVANCED SETTINGS DETAIL 1/5

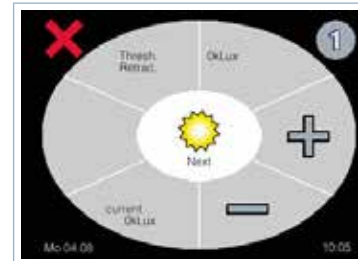

SETTING SUN THRESHOLD VALUE (RETRACT)

In this menu, a threshold value in klux is defined at which the shading system retracts. Additionally, the currently measured solar intensity is displayed in the lower left of the display. The threshold value can be adjusted individually using the + / - buttons.

Setting range: OFF, 11 – 99 klux

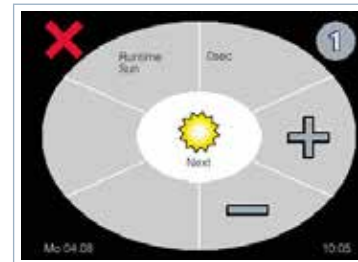

SETTING MOTOR RUNTIME (SUN)

In this menu, the motor runtime during a sun command is set. The runtime can be adjusted in seconds using the + / - buttons.

Setting range: 3 – 180 seconds

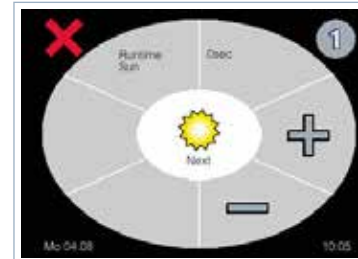

SETTING NUMBER OF SUN-DEPENDENT EXTENSION COMMANDS PER DAY

This setting defines how often the shading system extends automatically per day when the sun threshold is exceeded. Using the + / - buttons, the number of extension commands per day can be defined. "Unlimited" means no restriction.

Setting range: Unlimited, 1 – 10

i NOTE

If the number of sun-dependent extension commands is limited, no automatic retraction by the sun control will occur once the set number has been reached. The systems must then be retracted manually or via a timed command.

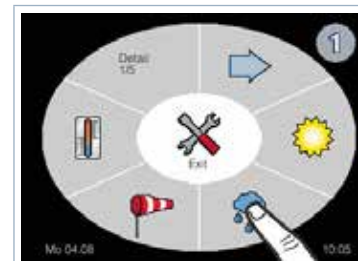

RAIN FUNCTION

The rain function protects the connected shading systems from rain. Function can be activated for the following control types:

- Awnings
- Skylights
- Venetian blinds

For safety reasons, this menu is password-protected. The 4-digit security code can be found on the invoice and is intended exclusively for qualified professionals.

INFORMATION FOR THE USER

ADVANCED SETTINGS DETAIL 1/5

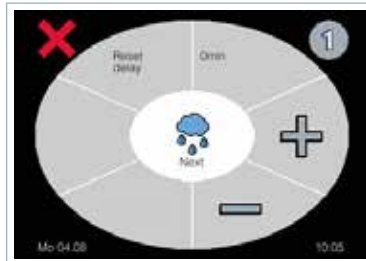
**SETTING RAIN RETURN DELAY**

As soon as the rain or frost sensor sends a signal, the configured return delay starts. After this delay, the system is retracted automatically, either controlled by sensors or time programs.

The delay can be adjusted individually using the + / - buttons.

Setting range: 1 – 60 minutes

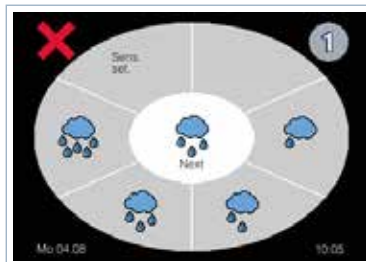
**SETTING RAIN SENSITIVITY**

The following four options are available:

- Very sensitive
- Normal sensitive
- Moderately sensitive
- Insensitive

✓ indicates the selected sensitivity level

**SETTING MANUAL OPERATION DURING RAIN/FROST**

This menu defines whether manual operation is allowed when rain or frost is detected.

✓ indicates that manual operation is enabled

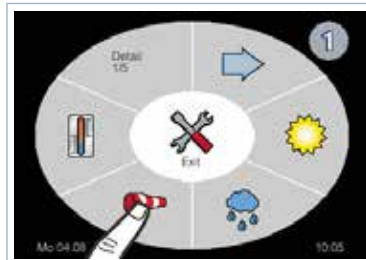
**WIND FUNCTION**

The wind function protects the connected system from strong wind. Function can be activated for the following control types:
• Awnings • Skylights • Venetian blinds

For safety reasons, this menu is password-protected. The 4-digit security code can be found on the invoice and is intended exclusively for qualified professionals.

INFORMATION FOR THE USER

ADVANCED SETTINGS DETAIL 1/5

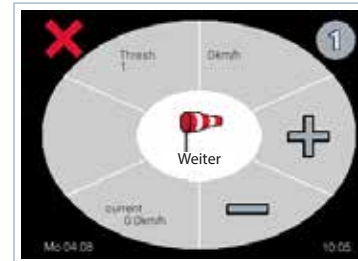
**SETTING WIND THRESHOLD 1**

In this menu, a wind threshold value is defined at which the shading system retracts immediately (or Skylights close). The value depends on the size and design of the system. Re-extension is only possible after the return delay has elapsed.

The wind threshold can be set using the + / - buttons.

Setting range: 10 – 100 km/h

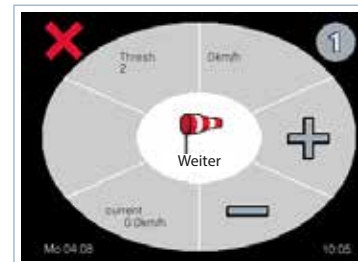
**SETTING WIND THRESHOLD 2**

In this menu, a second wind threshold is defined. When exceeded, the system retracts after the response delay. The value depends on the size and design of the system. Re-extension is only possible after the return delay has elapsed.

The wind threshold can be set using the + / - buttons.

Setting range: OFF, 10 – 99 km/h

**NOTE**

Wind threshold 2 cannot be set higher than wind threshold 1.

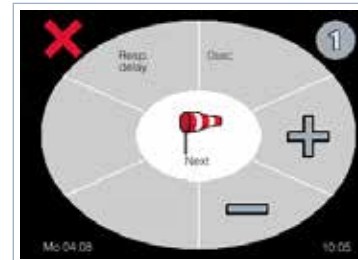
**SETTING WIND RESPONSE DELAY**

This setting defines a time in seconds after which the shading system retracts (or Skylights close), provided the wind threshold is still exceeded.

Setting range: OFF, 1 – 60 seconds

**NOTE**

If wind threshold 2 is set to OFF, this menu is not visible.

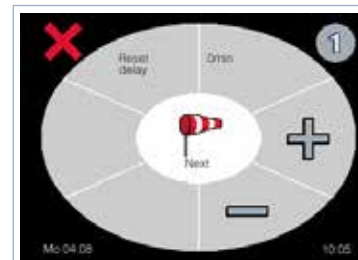
**SETTING WIND RETURN DELAY**

This setting defines a time in minutes after which, once the wind threshold is no longer exceeded, the shading system is automatically extended again. Control is performed via sensors or time programs.

Setting range: 1 – 60 minutes

INFORMATION FOR THE USER

ADVANCED SETTINGS DETAIL 1/5



SETTING WIND UNIT

In this menu, you can select the display unit for wind speed: km/h, m/s

✓ indicates the selected unit

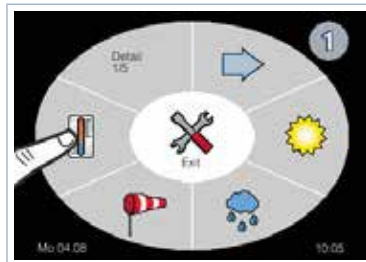

TEMPERATURE FUNCTION

The temperature function causes the shading system to retract when the set limit is exceeded. For Skylights, this means opening. If the sun function is also active, both limit values must be exceeded, otherwise no action is triggered. If the temperature falls below the threshold, the system extends again after the return delay or closes accordingly.

Function can be activated for the following control types:
• Awnings • Skylights • Venetian blinds • Roller shutters



NOTE

When using TE Indoor / TE Outdoor, the currently measured temperature is not displayed. Subsequent temperature function settings are not available.

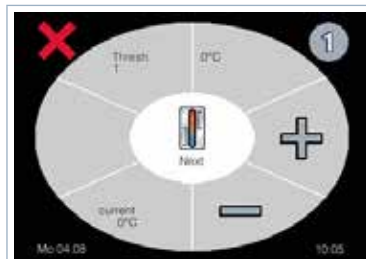

SETTING TEMPERATURE THRESHOLD 1

In this menu, a temperature threshold is defined at which: the shading system retracts or Skylights open

The value is set using the + / - buttons, while the current measured temperature is shown in the display.

Setting range: OFF, 15°C – 35°C

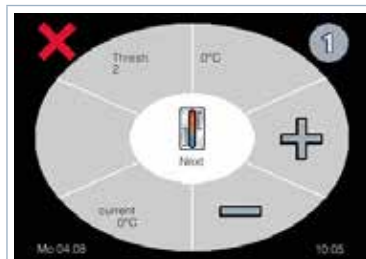

SETTING TEMPERATURE THRESHOLD 2

In this menu, a second temperature threshold is defined. When exceeded, Skylights open.

Additionally, a motor runtime can be set for partial opening. The value is adjusted using the + / - buttons.

Setting range: OFF, 15°C – 34°C

INFORMATION FOR THE USER

ADVANCED SETTINGS DETAIL 1/5



NOTE – TEMPERATURE THRESHOLD 2

Function is only available for Skylights with an analog temperature sensor. If threshold 1 is set to OFF, this menu is not visible. Temperature threshold 2 cannot be set higher than threshold 1.

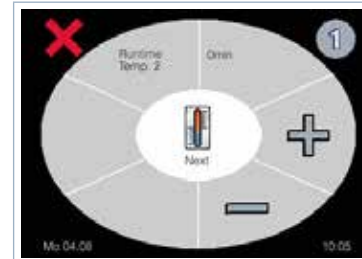

SETTING MOTOR RUNTIME FOR TEMPERATURE THRESHOLD 2

In this menu, an additional motor runtime is defined when temperature threshold 2 is exceeded. The time can be set in seconds using the + / - buttons to achieve partial window opening.

Setting range: OFF, 1 – 120 seconds



NOTE

Function only available for Skylights with: analog temperature sensor TS Pro XL or display box sensor If threshold 1 is OFF, this menu is not visible.

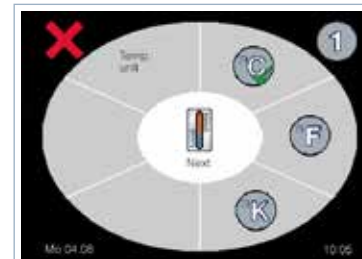

SETTING TEMPERATURE UNIT

In this menu, you can select the display unit for temperature:
°C (Celsius)
K (Kelvin)
°F (Fahrenheit)

✓ indicates the selected unit



NOTE

Function only available for Skylights with an assigned analog temperature sensor (TS Pro XL or display box). If temperature threshold 1 is set to OFF, this menu is not visible.

ADVANCED SETTINGS DETAIL 2/5



ADVANCED SETTINGS DETAIL 2/5

The following advanced settings can be configured:

- General motor runtime
- General Tilting function
- Continuous UP command
- Continuous DOWN command
- Go to page 3 of advanced settings or back to page 1

INFORMATION FOR THE USER

ADVANCED SETTINGS DETAIL 2/5

**MOTOR RUNTIME**

In this menu, a general motor runtime for extending (or opening) is defined. The value can be set in seconds using the + / - buttons.

Function can be activated for the following control types:
• Awnings • Skylights • Venetian blinds • Roller shutters

Setting range: Roller shutters / Skylights: 3 – 120 seconds
Setting range: Awnings / Venetian blinds: 3 – 180 seconds

NOTE:

If the MC DZ M/J function is activated, the functions: motor runtime, Tilting function, inching operation can no longer be set. These functions are then marked with a grey cross.

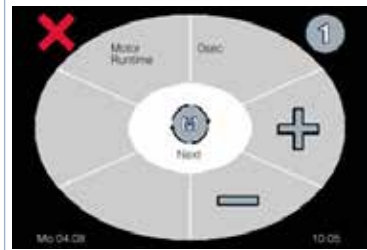
**TILTING FUNCTION**

In this menu, the Tilting time is set depending on the selected Tilting type:

- Tilting time by season
- Tilting time by table

as well as depending on the size and design of the shading system. The setting is made in 100 ms steps after the motor runtime has been executed. This allows a short reverse movement for precise positioning (e.g. slats). The function is executed both in automatic mode and in manual mode.

Function can be activated for the following control types:
• Awnings • Venetian blinds • Roller shutters

Setting range: OFF, 0.1 – 10 seconds

**NOTE**

Only one Tilting type per channel can be activated!

INFORMATION FOR THE USER

ADVANCED SETTINGS DETAIL 2/5

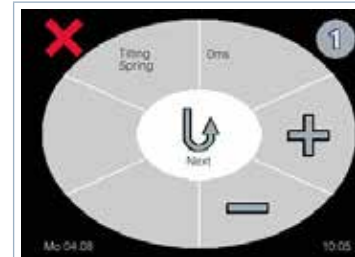
**TILTING TYPE: SEASON****SETTING TILTING TIME BY SEASON**

- Spring
- Summer
- Autumn
- Winter

In this menu, the Tilting time can be set individually for each season. If no Tilting is required, set the function to OFF. Using the key, the setting from the previous page is adopted and copied.

**TILTING TYPE: TABLE****SETTING TILTING TIME BY TABLE**

- January (time point 1)
- January (time point 2)
- January (time point 3)
- January (time point 4)
- ...
- December (time point 1)
- December (time point 2)
- December (time point 3)
- December (time point 4)

In this menu, the Tilting time is defined monthly in four daily recurring time periods.; The changeover occurs at fixed times: **08:00, 11:00, 14:00 und 17:00 Uhr**. Different Tilting times can be assigned to each time period (e.g. 08:00–11:00 and 11:00–14:00).

Between time point 4 and time point 1, the Tilting time from time point 4 remains active until time point 1 is reached again.

- Next time point of the month / first time point of the next month.
- Previous time point of the month / last time point of the previous month.
- Back to previous menu "Tilting time for selected time point".

**TILTING TYPE TABLE****SETTING TILTING TIME FOR EACH TIME POINT**

The Tilting time for each individual time point is set using the + / - buttons.

- Adopt Tilting time from previous page
- Return to previous time point

INFORMATION FOR THE USER

ADVANCED SETTINGS DETAIL 2/5

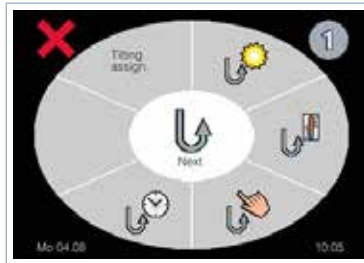

SETTING TILTING ASSIGNMENT

Here, the Tilting function is assigned to the individual functions:

- Tilting after execution of the sun function
- Tilting after execution of the temperature function
- Tilting after execution of a manual operation
- Continuous UP command
- Tilting after execution of a time command

i NOTE

If a channel group is assigned to both sun and temperature functions, the Tilting function for sun and temperature is automatically selected or deselected.



CONTINUOUS UP COMMAND

- If the function is active, the UP command is executed as long as the group button is pressed.
- If the function is inactive, the UP command is executed based on the set motor runtime after pressing the group button.s. Activation of the function is done by pressing the corresponding button.

CONTINUOUS DOWN COMMAND

- If the function is active, the DOWN command is executed as long as the group button is pressed.
- If the function is inactive, the DOWN command is executed based on the set motor runtime after pressing the group button. Activation of the function is done by pressing the corresponding button.

i NOTE

When the group button is pressed, operation via the display is not possible.

INFORMATION FOR THE USER

ADVANCED SETTINGS DETAIL 3/5

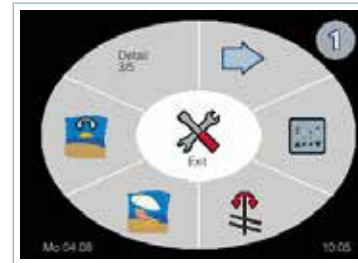

ADVANCED SETTINGS DETAIL 3/5

The following advanced settings can be configured:

- MC DZ M/J function
- Inching operation function
- Holiday function
- Astro function
- Go to page 4 of advanced settings or back to page 1



MC DZ M/J FUNCTION

The MC DZ M/J function is used exclusively for controlling decentralized control units of type: MC P1, MC P2, MC P4 in operating modes 4, 5 and 6.

Function can be activated for the following control types:

- Awnings
- Venetian blinds
- Roller shutters

This menu is password-protected for security reasons. The 4-digit security code is provided on the invoice and is intended for qualified personnel only.

i NOTE

Activating the MC DZ M/J function disables all motor runtimes and Tilting times for the respective channel group. Commands must then be configured on the decentralized control units MC P1, MC P2 and MC P4.



INCHING OPERATION FUNCTION

If the function is activated, a inching operation of up to 2 seconds is possible. After 2 seconds, the runtime command is executed.

Function only available for: • Venetian blinds



HOLIDAY FUNCTION

The function generates random movements of the shading system with a deviation of up to ± 15 minutes from the programmed time and travel direction. This simulates presence and provides additional protection during longer absences. Function only available for:

- Venetian blinds
- Roller shutters
- Lighting

- Holiday function deactivated (activate by selection)
- Holiday function activated

INFORMATION FOR THE USER

ADVANCED SETTINGS DETAIL 3/5



ASTROFUNKTION

The astro function is an electronic calendar that automatically calculates sunrise and sunset times based on geographic coordinates and seasons. Additionally, it operates in combination with the set UP and DOWN travel times. To use the astro function, you must enter the coordinates of your location (see following pages).

Function only available for:

- Venetian blinds
- Roller shutters
- Lighting

ASTROTABELLE

Programmed UP time	before	morning astro time	Shutter moves up at astro time	later time applies
Programmed UP time	after	morning astro time	Shutter moves up at programmed time	
Programmed DOWN time	after	evening astro time	Shutter moves down at astro time	earlier time applies
Programmed DOWN time	before	evening astro time	Shutter moves down at programmed time	

i NOTE

The astro function can be disabled for any weekday by setting the time function for that day to "OFF".

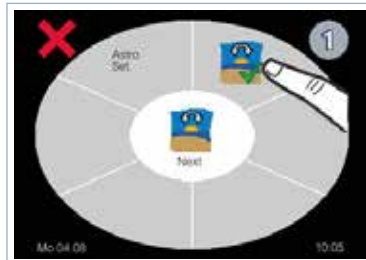

ASTRO SETTINGS

Further settings are only possible when the astro function is activated:

- indicates that the astro function is active
- Activation via clicking the symbol

Proceed to the longitude menu (LON) by selecting "Next".

i NOTE

On the following pages, you will find a list of cities with corresponding longitude and latitude values.



SETTING LONGITUDE (LON)

In this menu, the longitude of your location is entered. Input is made in degrees and minutes using the + / - buttons.

INFORMATION FOR THE USER

ADVANCED SETTINGS DETAIL 3/5



SETTING LATITUDE (LAT)

In this menu, the latitude of your location is entered. Input is made in degrees and minutes using the + / - buttons.

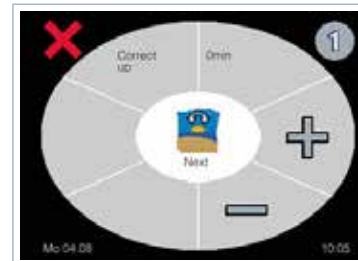

SETTING CORRECTION TIME UP

If you are not satisfied with the preset astro time for sunrise, you can adjust the UP command time individually using the + / - buttons.

Adjustment range: +/- 59 minutes



SETTING CORRECTION TIME DOWN

If you are not satisfied with the preset astro time for sunset, you can adjust the DOWN command time individually using the + / - buttons.

Adjustment range: +/- 59 minutes

INFORMATION FOR THE USER

ADVANCED SETTINGS: DETAIL 3/5 | LIST OF GERMAN CITIES FOR THE ASTRO FUNCTION

CITY	COUNTRY	LONGITUDE (LON ° : MIN)	LATITUDE (LAT ° : MIN)
Salzburg	A	13°02	47°48
Tirol	A	11°20	47°15
Wien	A	16°23	48°13
Brüssel	B	04°21	50°50
Bern	CH	07°26	46°56
Zürich	CH	08°33	47°22
Prag	CZ	14°25	50°05
Aachen	D	06°05	50°46
Berlin	D	13°24	52°31
Bremen	D	08°48	53°04
Bonn	D	07°05	50°43
Cottbus	D	14°19	51°45
Dortmund	D	07°27	51°31
Dresden	D	13°44	51°03
Duisburg	D	06°45	51°26
Düsseldorf	D	06°46	51°13
Frankfurt a. M.	D	08°41	50°07
Hamburg	D	10°00	53°33
Hannover	D	09°43	52°22
Innsbruck	D	11°23	47°15
Kaiserslautern	D	07°46	49°26
Karlsruhe	D	08°24	49°00
Kassel	D	09°29	51°19
Kiel	D	10°08	54°19
Köln	D	06°57	50°56
Leipzig	D	12°22	51°20
Mainz	D	08°16	49°59
Mannheim	D	08°28	49°29
München	D	11°34	48°08
Münster	D	07°37	51°57
Nürnberg	D	11°05	49°25
Regensburg	D	12°06	49°00
Stuttgart	D	09°11	48°46
Ulm	D	09°59	48°23
Würzburg	D	09°55	49°47

INFORMATION FOR THE USER

ADVANCED SETTINGS: DETAIL 3/5 | LIST OF GERMAN CITIES FOR THE ASTRO FUNCTION

CITY	COUNTRY	LONGITUDE (LON ° : MIN)	LATITUDE (LAT ° : MIN)
Kopenhagen	DK	12°34	55°40
Barcelona	E	02°09	41°23
Madrid	E	-03°42	40°24
Dijon	F	05°01	47°19
Marseille	F	05°24	43°18
Paris	F	02°20	48°52
Helsinki	FIN	24°56	60°10
Kuopio	FIN	27°41	62°54
Tampere	FIN	23°45	61°30
Birmingham	GB	-01°55	52°28
London	GB	-00°07	51°30
Manchester	GB	-02°14	53°28
Mailand	I	09°11	45°27
Neapel	I	14°15	40°50
Rom	I	12°29	41°54
Dublin	IRL	-06°14	53°19
Luxemburg	L	06°08	49°37
Oslo	N	10°44	59°54
Trondheim	N	10°25	63°25
Amsterdam	NL	04°53	52°22
Eindhoven	NL	05°28	51°26
Rotterdam	NL	04°28	51°55
Moskau	RUS	37°36	55°45
Göteborg	S	11°58	57°42
Stockholm	S	18°03	59°19

INFORMATION FOR THE USER

ADVANCED SETTINGS DETAIL 4/5



ADVANCED SETTINGS DETAIL 4/5

The following advanced settings can be configured:

- Time function UP
- Time function DOWN
- Automatic mode lock
- Handheld transmitter programming/deletion (no function)
- Go to page 5 of advanced settings or back to page 1



TIME FUNCTION UP

Using the time function UP, a time can be defined for each channel group at which: the shading system retracts, Skylights close, lighting, ventilation or heating are switched ON

Individual times can be set for each weekday using the + / - buttons, while the duration is defined in the next menu.



Monday UP



Monday duration



Sunday UP



Sunday duration

Function only available for:

- Awnings • Venetian blinds • Skylights • Roller shutters • Lighting • Ventilation • Heating

Apply settings from the previous page

INFORMATION FOR THE USER

ADVANCED SETTINGS DETAIL 4/5

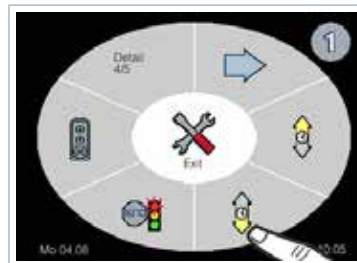

TIME FUNCTION DOWN

Using the time function DOWN, a time can be defined for each channel group at which the shading system extends, Skylights open

Individual times can be set for each weekday using the + / - buttons, while the duration is defined in the next menu.



Monday DOWN



Monday duration



Sunday DOWN



Sunday duration

Function only available for:

- Awnings • Venetian blinds • Skylights • Roller shutters

Apply settings from the previous page



AUTOMATIC MODE LOCK

In this menu, a time window can be defined for each weekday during which automatic control is deactivated, no sensor-based or time-based commands are executed.

Activation is done by setting the start time using the + / - button



Monday OFF

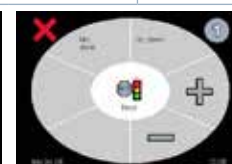

Monday duration



Sunday OFF



Sunday duration

Function only available for:

- Awnings • Venetian blinds • Skylights • Roller shutters • Ventilation • Heating

Apply settings from the previous page

Proceed to setting the duration of the automatic lock

Proceed to setting the next weekday

INFORMATION FOR THE USER

ADVANCED SETTINGS DETAIL 4/5



PROGRAM / DELETE HANDHELD TRANSMITTER (NO FUNCTION)

In this menu, optionally available handheld transmitters can be programmed or deleted.

This function is currently not active for any control types.



Programming a transmitter: Press the transmitter button (green arrow) While it is flashing, press the button of the transmitter to be programmed.



Deleting a transmitter: Press the transmitter button (red arrow) While it is flashing, press the button of the transmitter to be deleted

ADVANCED SETTINGS DETAIL 5/5



ADVANCED SETTINGS DETAIL 5/5

The following advanced settings can be configured:

-  Heating function
-  Ventilation function
-  Go to page 5 of advanced settings or back to page 1



HEATING FUNCTION

The heating function automatically switches the heating ON when the temperature falls below the set threshold. Additionally, a frost protection function is activated if a lower limit is reached.

Function only available for • Heating

INFORMATION FOR THE USER

ADVANCED SETTINGS DETAIL 5/5

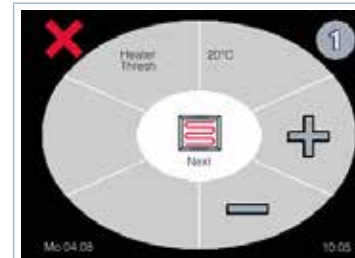

SETTING TEMPERATURE THRESHOLD

In this menu, a temperature threshold is defined. When the temperature falls below this value heating is switched ON. When the temperature rises again heating is switched OFF after the return delay.

Setting range: OFF, 15°C – 35°C

The temperature threshold is set using the + / – buttons.



NOTE

When using TE Indoor / TE Outdoor, the measured temperature is not displayed. Subsequent settings are not available.

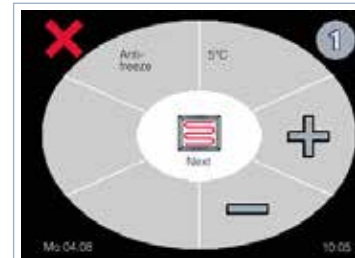

SETTING FROST PROTECTION

In this menu, a frost protection temperature threshold is defined. When the temperature falls below this value heating is switched ON. When the temperature rises above this value heating is switched OFF automatically after the return delay.

Setting range: OFF, 3°C – 10°C

The temperature threshold is set using the + / – buttons.

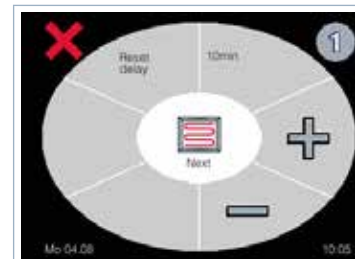

SETTING RETURN DELAY

The return delay delays the immediate switching OFF of the heating after the temperature threshold has been exceeded.

With the + / – buttons, the delay can be set in minutes.

Setting range: 1 – 60 minutes



SETTING TEMPERATURE UNIT

In this menu, you can select the display unit for temperature:
°C (Celsius)
K (Kelvin)
°F (Fahrenheit)

✓ indicates the selected unit.

INFORMATION FOR THE USER

ADVANCED SETTINGS DETAIL 5/5

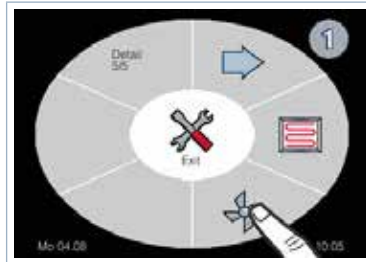

VENTILATION FUNCTION

The ventilation function switches the connected ventilation system ON when the set temperature threshold is exceeded.

Function only available for • Ventilation

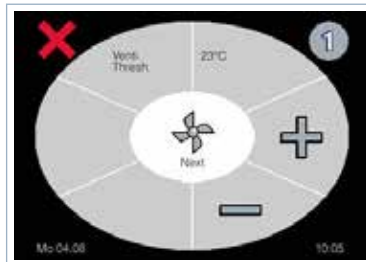

SETTING TEMPERATURE THRESHOLD

In this menu, a temperature threshold is defined at which the connected ventilation system is activated.

The desired temperature threshold is set using the + / - buttons.

Setting range: OFF, 15°C – 35°C



NOTE

When using TE Indoor / TE Outdoor, the measured temperature is not displayed. Subsequent settings are not available.

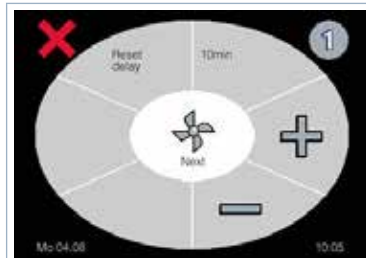

SETTING RETURN DELAY

The return delay delays the immediate switching OFF of the ventilation after the temperature threshold has been exceeded.

The delay can be set in minutes using the + / - buttons.

Setting range: 1 – 60 minutes

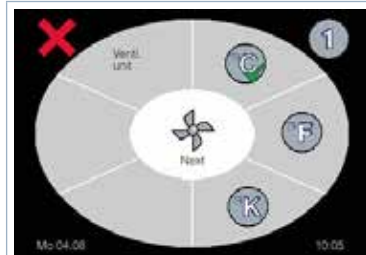

SETTING TEMPERATURE UNIT

In this menu, you can select the display unit for temperature:
°C (Celsius)
K (Kelvin)
°F (Fahrenheit)

✓ indicates the selected unit

CONTROL UNIT WARNINGS

INFORMATION FOR THE USER

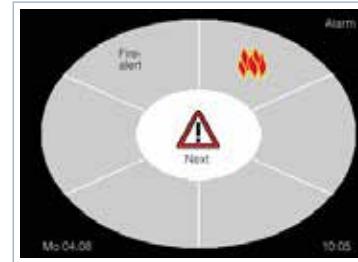

FIRE ALARM

A triggered fire alarm is displayed on the screen. If manual reset is configured, the alarm must be confirmed on the display after it has been reset at the fire alarm control panel.

If automatic reset is configured, the alarm will reset automatically after the fire alarm control panel has been reset.



WIND SENSOR CABLE BREAK

If the connection cable of a wind sensor is damaged, the defect is displayed. The display switches to an error indication showing the affected sensor. Shading systems controlled by the defective wind sensor retract immediately or remain secured in the retracted position.

Manual operation is not possible.



NOTE

The following warnings can be acknowledged with the "Next" button, but will reappear after one hour.



WIND SENSOR 48-HOUR ALARM

If wind sensors do not send any signal for 48 hours, a warning is displayed. This indicates that the sensors must be checked (e.g. by manually moving the rotor). If the message remains after testing safe operation is no longer guaranteed, the system should be taken out of operation and secured.

Shading systems retract automatically or remain locked.



LUX SENSOR CABLE BREAK

If the connection cable of a lux sensor is damaged, the defect is displayed. The display switches to an error indication showing the affected sensor.

CONTROL UNIT WARNINGS

INFORMATION FOR THE USER



TEMPERATURE SENSOR CABLE BREAK

If the connection cable of the temperature sensor TS Pro XL is damaged, this fault will be displayed on the screen. The display then switches to an error indication showing the affected sensor.



















DESCRIPTION OF SYMBOLS

SYMBOLS GENERAL

	Function enabled		Function cannot be enabled
	Function disabled		Back to previous menu
	Settings menu		Automatic lock active
	Caution / warning		Note / information
	UP: retract sunshade / open skylight		DOWN: extend sunshade / close window
	Back to previous menu		Copy function
	ON: switch on lighting, heating or ventilation		OFF: switch off lighting, heating or ventilation
	Switched on lighting, heating or ventilation		Switched off lighting, heating or ventilation
	Device lock function activated		Device unlocked
	Plus / increase setting value		Minus / decrease setting value
	Manufacturer logo		
	Automatic mode		Manual operation
	Channel group one		Channel group two
	Channel group three		Channel group four
	Control system type: awning		Control system type: lighting
	Control system type: blind		Control system type: ventilation
	Control system type: skylight		Control system type: heating
	Control system type: shutter		Not connected, not connected to this channel group























DESCRIPTION OF SYMBOLS

INSTALLATION ASSISTENT (WIZARD) SYMBOLS

	Wizard		Go to next menu
	Password input		Language German
	Language English		Language Norwegian
	Language Swedish		Language Nederlands
	Language French		Language Hungarian
	Language Czech		Language Polish
	Language Romanian		In progress
	Communication via 4-wire interface		Radio communication (without function)
	No connection		Low signal strength
	Sufficient signal strength		Good signal strength
	Sensor selection: lux sensor LS 30		Sensor assignment: lux sensors 1 to 8
	Sensor selection: wind sensors 1 or 2		Sensor assignment: wind sensors 1 and 2
	Sensor selection general		Sensor assignment: temperature sensor TS Pro XL
	Sensor selection: display box temperature sensor		Sensor assignment: temperature sensors TE Indoor or TE Outdoor
	Rain sensor activation RD +1 °C or RD -20 °C		radio-controlled clock receiver
	Move to safety position		



















DESCRIPTION OF SYMBOLS

INFO & COMFORT MENU SYMBOLS

	Weather info / status indication		To return to user menu
	Lock / unlock display		Display lock
	Comfort buttons		Comfort buttons 1 to 4
	Info on retract comfort setting		Info on extend comfort setting
	Info on retract following fire alarm		Info on retract anti-freeze
	Info on retract manual function		Info on extend manual function
	Info on retract rain function		
	Info on retract sun function		Info on extend sun function
	Info on retract temperature function		Info on extend temperature function
	Above set temperature		Below set temperature
	Info on retract clock function		Info on extend clock function
	Info on retract wind function		
	Info on retract maintenance function		Info on extend maintenance function
	Info move to safety position		





































DESCRIPTION OF SYMBOLS

BASIC SETTINGS SYMBOLS

	To return to user menu		
	Time / date		Display colour selection
	Display background colour 1		Display background colour 2
	Display background colour 3		Display standby time
	Release following fire alarm		
	Manual release following fire alarm		Automatic release following fire alarm
	Network settings (without function)		Display logbook
	Display manufacturer contact		Display software version
	Move to safety position		Touchscreen calibration
	Display/start wizard		Restore factory settings

DESCRIPTION OF SYMBOLS

FINE ADJUSTMENTS SYMBOLS

	To return to user menu		Sun function
	Rain function		Rain sensitivity: high sensitivity
	Rain sensitivity: normal sensitivity		Rain sensitivity: moderate sensitivity
	Rain sensitivity: no sensitivity		Manual extension when rain/frost
	Anti-freeze function		Wind function
	Wind speed display in km/h		Wind speed display in m/s
	Temperature function		Temperature in Celsius
	Temperature in Fahrenheit		Temperature in Kelvin
	Motor runtime setting		Tilting function
	Jump forward to the next time in the tilting table.		Jump back to the previous time in the tilting table.
	Tilting performance related to sun function		Tilting performance related to temperature function
	Tilting performance related to manual function		Tilting performance related to time function
	Continuous up command		Continuous down command
	MC DZ M/J function		Inching mode function
	Holiday function		Astro function
	Retract / skylight open time function		Extend / skylight close time function
	Automatic mode setting		Programming/Deleting handheld transmitter (without function)
	Teach in handheld transmitter (without function)		Delete handheld transmitter (without function)
	Heating function		Ventilation function

FACTORY DEFAULT SETTINGS

Settings	Awning	Venetian Blind	Shutters	Roof Window	Lighting	Ventilation	Heating
DOWN time function lighting / ventilation / heating OFF	✓	✓	✓	✓	✗	✗	✗
Monday	OFF	OFF	20:00	OFF			
Duration	OFF	OFF	OFF	OFF			
Tuesday	OFF	OFF	20:00	OFF			
Duration	OFF	OFF	OFF	OFF			
Wednesday	OFF	OFF	20:00	OFF			
Duration	OFF	OFF	OFF	OFF			
Thursday	OFF	OFF	20:00	OFF			
Duration	OFF	OFF	OFF	OFF			
Friday	OFF	OFF	20:00	OFF			
Duration	OFF	OFF	OFF	OFF			
Saturday	OFF	OFF	20:00	OFF			
Duration	OFF	OFF	OFF	OFF			
Sunday	OFF	OFF	20:00	OFF			
Duration	OFF	OFF	OFF	OFF			
Automatic mode lock	✓	✓	✓	✓	✗	✓	✓
Monday	OFF	OFF	20:00	OFF		OFF	OFF
Duration	OFF	OFF	12 h	OFF		OFF	OFF
Tuesday	OFF	OFF	20:00	OFF		OFF	OFF
Duration	OFF	OFF	12 h	OFF		OFF	OFF
Wednesday	OFF	OFF	20:00	OFF		OFF	OFF
Duration	OFF	OFF	12 h	OFF		OFF	OFF
Thursday	OFF	OFF	20:00	OFF		OFF	OFF
Duration	OFF	OFF	12 h	OFF		OFF	OFF
Friday	OFF	OFF	20:00	OFF		OFF	OFF
Duration	OFF	OFF	12 h	OFF		OFF	OFF
Saturday	OFF	OFF	20:00	OFF		OFF	OFF
Duration	OFF	OFF	12 h	OFF		OFF	OFF
Sunday	OFF	OFF	20:00	OFF		OFF	OFF
Duration	OFF	OFF	12 h	OFF		OFF	OFF
Heating function	✗	✗	✗	✗	✗	✗	✓
Temperature threshold							20°C
Anti-freeze							5°C
Reset delay							10 min.
Temperature unit							°C
Ventilation function	✗	✗	✗	✗	✗	✓	✗
Temperature threshold							23°
Reset delay							10 min.
Temperature unit							°C
Fire function	✓	✓	✓	✓	✗	✓	✓
Setting	with confirmation	with confirmation	with confirmation	with confirmation		with confirmation	with confirmation

PERSONAL SETTINGS

INFORMATION FOR THE USER – PERSONAL SETTINGS

Settings	Awning	Venetian Blind	Shutters	Roof Window	Lighting	Ventilation	Heating
Sun function				✗	✗	✗	✗
Extension sun threshold				✗	✗	✗	✗
Extension response time				✗	✗	✗	✗
Retract time delay				✗	✗	✗	✗
Retract sun threshold				✗	✗	✗	✗
Sun motor runtime				✗	✗	✗	✗
Number of sun-dependent extension commands per day				✗	✗	✗	✗
Rain function			✗		✗	✗	✗
Reset delay			✗		✗	✗	✗
Sensitivity setting			✗		✗	✗	✗
Manual extension when rain/frost			✗		✗	✗	✗
Wind function			✗		✗	✗	✗
Wind threshold 1			✗		✗	✗	✗
Wind threshold 2			✗		✗	✗	✗
Response delay			✗		✗	✗	✗
Reset delay			✗		✗	✗	✗
Wind unit			✗		✗	✗	✗
Temperature function					✗	✗	✗
Temperature threshold 1					✗	✗	✗
Temperature threshold 2	✗	✗	✗		✗	✗	✗
Runtime for temperature threshold 2	✗	✗	✗		✗	✗	✗
Reset delay					✗	✗	✗
Temperature unit					✗	✗	✗
Motor run time					✗	✗	✗
Setting					✗	✗	✗
Tilting function				✗	✗	✗	✗
Tilting time spring				✗	✗	✗	✗
Tilting time summer				✗	✗	✗	✗
Tilting time autumn				✗	✗	✗	✗
Tilting time winter				✗	✗	✗	✗
Tilting assignment by sun				✗	✗	✗	✗
Tilting assignment by temperatur				✗	✗	✗	✗
Tilting assignment by manual op.				✗	✗	✗	✗
Tilting assignment by time				✗	✗	✗	✗
Continuous up command					✗	✗	✗
Setting					✗	✗	✗
Continuous down command					✗	✗	✗
Setting					✗	✗	✗
MC DZ MJ function				✗	✗	✗	✗
Setting				✗	✗	✗	✗

PERSONAL SETTINGS

INFORMATION FOR THE USER – PERSONAL SETTINGS

Settings	Awning	Venetian Blind	Shutters	Roof Window	Lighting	Ventilation	Heating
Inching mode function	✗		✗	✗	✗	✗	✗
Setting	✗		✗	✗	✗	✗	✗
Holiday function	✗			✗		✗	✗
Setting	✗			✗		✗	✗
Astro function	✗			✗		✗	✗
Setting	✗			✗		✗	✗
Longitude LON	✗			✗		✗	✗
Latitude LAT	✗			✗		✗	✗
Up time correction	✗			✗		✗	✗
Down time correction	✗			✗		✗	✗
UP time function lighting / ventilation / heating ON							
Monday							
Duration							
Tuesday							
Duration							
Wednesday							
Duration							
Thursday							
Duration							
Friday							
Duration							
Saturday							
Duration							
Sunday							
Duration							
DOWN time function lighting / ventilation / heating OFF					✗	✗	✗
Monday					✗	✗	✗
Duration					✗	✗	✗
Tuesday					✗	✗	✗
Duration					✗	✗	✗
Wednesday					✗	✗	✗
Duration					✗	✗	✗
Thursday					✗	✗	✗
Duration					✗	✗	✗
Friday					✗	✗	✗
Duration					✗	✗	✗
Saturday					✗	✗	✗
Duration					✗	✗	✗
Sunday					✗	✗	✗
Duration					✗	✗	✗

PERSONAL SETTINGS

INFORMATION FOR THE USER – PERSONAL SETTINGS

Settings	Awning	Venetian Blind	Shutters	Roof Window	Lighting	Ventilation	Heating
Automatic mode lock					✗		
Monday					✗		
Duration					✗		
Tuesday					✗		
Duration					✗		
Wednesday					✗		
Duration					✗		
Thursday					✗		
Duration					✗		
Friday					✗		
Duration					✗		
Saturday					✗		
Duration					✗		
Sunday					✗		
Duration					✗		
Heating function	✗	✗	✗	✗	✗	✗	
Temperature threshold	✗	✗	✗	✗	✗	✗	
Anti-freeze	✗	✗	✗	✗	✗	✗	
Reset delay	✗	✗	✗	✗	✗	✗	
Temperature unit	✗	✗	✗	✗	✗	✗	
Ventilation function	✗	✗	✗	✗	✗		✗
Temperature threshold	✗	✗	✗	✗	✗		✗
Reset delay	✗	✗	✗	✗	✗		✗
Temperature unit	✗	✗	✗	✗	✗		✗
Fire function					✗		
Setting					✗		

TROUBLESHOOTING

Error	Cause of Error	Troubleshooting
Control system does not function	<ul style="list-style-type: none"> Power failure Fault in the connection area of the control system 	<ul style="list-style-type: none"> Wait until power supply is restored Check 160 mA T fine-wire fuse and replace if necessary Check connection according to wiring diagram
Connected motors do not move in or out, skylights do not open or close	<ul style="list-style-type: none"> Fine-wire fuse in the motor box is faulty No wire bridge between Common and L1 (only in the case of direct motor connection!) 	<ul style="list-style-type: none"> Check 6.3 A T fine-wire fuse and replace if necessary Check wire bridge between Common and L1
No display box display	<ul style="list-style-type: none"> Fault in the connection of the 4-wire interface 	<ul style="list-style-type: none"> Check connection according to wiring diagram
Display turns off after short period	<ul style="list-style-type: none"> Standby time set to 1 minute 	<ul style="list-style-type: none"> Adjust standby time to required level
No or insufficient radio-controlled clock reception	<ul style="list-style-type: none"> Signal strength is too low 	<ul style="list-style-type: none"> Check connection according to wiring diagram Change the mounting position of the radio-controlled clock receiver
48 h wind sensor alarm display	<ul style="list-style-type: none"> Wind sensor blocked No wind over the last 48 hours 	<ul style="list-style-type: none"> Check the affected wind sensor
Wind sensor cable rupture display	<ul style="list-style-type: none"> Wind sensor's connecting cable damaged Fault in connection area 	<ul style="list-style-type: none"> Check connection according to wiring diagram Check connecting cable for damage
Lux sensor cable rupture display	<ul style="list-style-type: none"> Lux sensor's connecting cable damaged Fault in connection area 	<ul style="list-style-type: none"> Check connection according to wiring diagram Check connecting cable for damage
Wind speed display too low	<ul style="list-style-type: none"> Wind sensor is not positioned fully in the area of wind flow Incorrect wind sensor type is set 	<ul style="list-style-type: none"> Check the wind sensor position and change if necessary Check the smooth running of the wind wheel Check settings in the wizard
Lux sensor displays readings that are too low	<ul style="list-style-type: none"> Lux sensor is in the shade Lux sensor is soiled or covered 	<ul style="list-style-type: none"> Check the lux sensor position and change if necessary Remove any soiling
Lux sensor displays readings that are too high	<ul style="list-style-type: none"> Lux sensor is affected by reflected light Strong lighting in the vicinity of the lux sensor 	<ul style="list-style-type: none"> Check the lux sensor position and change if necessary

TROUBLESHOOTING

Error	Cause of Error	Troubleshooting
The sunshade has travelled to its upper end position and can no longer be controlled manually	<ul style="list-style-type: none"> Wind alarm active Rain/frost alarm active Maintenance switch active Fire alarm triggered, manual reset selected 	<ul style="list-style-type: none"> Adjust the wind threshold according to the instructions of the sunshade manufacturer Activate manual extension in case of rain rain/frost alarm Fire alarm release selected
No automatic movement of sunshade in response to sun, temperature or time commands	<ul style="list-style-type: none"> Sun/temperature thresholds set too high No time commands programmed Control system is in manual mode 	<ul style="list-style-type: none"> Adjustment of the appropriate thresholds Program time control Select automatic mode
No retraction during strong winds	<ul style="list-style-type: none"> Wind threshold set too high 	<ul style="list-style-type: none"> Adjust the wind threshold according to the instructions of the sunshade manufacturer
When in manual mode, the blinds do not tilt and move directly into their upper end position	<ul style="list-style-type: none"> Inching mode for that channel group is switched off 	<ul style="list-style-type: none"> Select channel group and switch on inching mode under fine adjustments
During sunshine, shade moves into its lower end position too late	<ul style="list-style-type: none"> Incorrect lux sensor selected Lux sensor is soiled Lux sensor is shaded Extend sun threshold setting is too high Response time setting is too long Automatic lock is active 	<ul style="list-style-type: none"> Change lux sensor assignment Clean lux sensor Change the lux sensor position Decrease threshold for extend sun function Decrease sun function response time Switch off automatic lock or adjust start time and duration
In cloudy conditions, shade moves into its upper end position too late	<ul style="list-style-type: none"> Threshold for retract sun function is set too high Response time setting is too long 	<ul style="list-style-type: none"> Decrease threshold for extend sun function Decrease sun function response time
In cloudy conditions, shade moves into its upper end position too early	<ul style="list-style-type: none"> Threshold for retract sun function is set too low Response time setting is too short 	<ul style="list-style-type: none"> Raise threshold for retract sun function Increase sun function response time
Sunshade does not automatically move into its upper position in the evening	<ul style="list-style-type: none"> Retract threshold setting is too low Lux sensor is affected by strong light source Sunshade has been lowered manually 	<ul style="list-style-type: none"> Raise threshold for retract sun function Check the lux sensors' readings Retract the sunshade manually Check automatic lock
Skylight opens too late	<ul style="list-style-type: none"> Temperature threshold setting for 'open skylight' is too high 	<ul style="list-style-type: none"> Decrease threshold for temperature function

TROUBLESHOOTING

Error	Cause of Error	Troubleshooting
Skylight only partially opens	<ul style="list-style-type: none"> ■ Temperature threshold 2 for skylight has been exceeded 	<ul style="list-style-type: none"> ■ Decrease temperature threshold 1 for skylight function ■ Increase motor runtime for skylight function
No automatic retraction of sunshade during rain when in manual mode	<ul style="list-style-type: none"> ■ Rain/frost alarm not active in manual mode 	<ul style="list-style-type: none"> ■ Change rain/frost alarm setting for manual mode
Connected sunshades extend for only 3 seconds in response to sun / temperature	<ul style="list-style-type: none"> ■ MC DZ M/J function is active ■ Runtime is set to 3 seconds 	<ul style="list-style-type: none"> ■ Deactivate MC DZ M/J function ■ Adjust sunshade runtime

WARRANTY/MAINTENANCE

Principally, the General Terms and Conditions of the manufacturer, Vestamatic International GmbH apply. The terms and conditions are part of the sales documents and handed over to the operator upon delivery. Liability claims for personal or material damages are excluded when they can be attributed to one or more of the following causes:

- Unintended use of the product.
- Opening of the product by the customer.
- Improper installation, commissioning, or operation of the product.
- Non-compliance with the specifications.
- Non-observance of the safety provisions and instructions of the Operating Instructions.
- Operation of the product with improperly installed connections, defective safety devices or improperly installed safeguards.
- Modifications to the product.

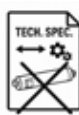

MAINTENANCE

The product is maintenance-free.